

# AMANDATOUR WEB SERVICE Project XML

Version 0.1.2-04/08/2008

Author: Giorgio Servizio

Support: support@Ambergris.it

1	Introduction .....	2
1.1	Overview.....	2
1.2	System Testing.....	2
1.3	Purpose of this document.....	2
1.4	Related Documents.....	2
1.5	Message Summary .....	2
1.5.1	Session Management.....	3
1.5.2	Search for Availability .....	3
1.5.3	Booking.....	3
1.5.4	Hotels Information.....	3
1.5.5	Errors .....	4
2	Login .....	5
2.1	Login_request.....	5
2.2	Login_response.....	6
3	AvailabilityList.....	7
3.1	AvailabilityList_Request .....	7
3.2	AvailabilityList_Response.....	9
4	Booking .....	18
4.1	MakeBooking_Request .....	18
4.2	MakeBooking_Response .....	21
4.3	ReviseBooking_Request.....	24
4.4	ReviseBooking_Response .....	25
4.5	ChangeBooking_Request .....	30
4.6	ChangeBooking_Response .....	31
4.7	CancelBooking_Request.....	32
4.8	CancelBooking_Response.....	33
5	HotelsList .....	34
5.1	HotelsList_Request .....	34
5.2	HotelList_Response .....	35
6	HotelDetails.....	38
6.1	HotelDetail_Request .....	38
6.2	HotelDetail_Response.....	39

# 1 Introduction

## 1.1 Overview

The Amandatour Web Service allows to book all hotels featured in the website [www.amandatour.com](http://www.amandatour.com).

This document provides a detailed functional description of the Amandatour Web Service

## 1.2 System Testing

- During the interface development the Client may carry out all necessary test by connecting with <http://ws.amandatour.com/ambergris.it>.
- All transactions and bookings carried out by the username "XXXXClient" (Login) will be considered as trials. The password will be delivered by Amandatour after the contract's signature.
- A technical support may be requested by sending an e-mail to [support@ambergris.it](mailto:support@ambergris.it), mentioning the subject "Web Service Amandatour"
- At the end of the development efforts the Client shall agree with Amandatour the operational mode and procedure to start up the On-Line Booking
- To test directly the XML request messages we suggest to use the SOAP CLIENT <http://www.soapclient.com/soapstest.html>

## 1.3 Purpose of this document

Each transaction in the Amandatour Web Service includes one request message and a corresponding response message. Each of these messages are formally defined in a set of XML Schema Definition files. The purpose of this document is to provide supporting information for the XML-Schema Definition including:

- The purpose of each transaction and how it relates to other transactions;
- A description of each message's elements and attributes;
- At least one example of each request and response message;

## 1.4 Related Documents

### XML-Schema files

The formal specification of all the messages in XML-Schema format. The messages are grouped into XML Schema Definition files. These files are best viewed using an XML-Schema design tool such as XML Spy (see <http://www.xmlspy.com/>)

## 1.5 Message Summary

The XML messages are grouped into several XML Schema files as described below.

## 1.5.1 Session Management

Messages relating to sessions, including logging in/out.

**Login** Initiates a session on the system. Returns a "AuthenticationToken", which must be used in all subsequent transactions.

**Logout** Terminates a session.

To end the session it is not necessary to logout as the system will automatically do it at the end of each transaction made by a Request and related Response

## 1.5.2 Search for Availability

### AvailabilityList

Schema File: AvailabilityList\_Request.xsd

The above search is performed against a selected hotel programme (Agreement). This message is used to return the list of agreements that is available to be searched.

## 1.5.3 Booking

Schema File: Booking.xsd

Messages for making, revising, cancelling and linking bookings.

### MakeBooking

Schema File: MakeBooking\_Request.xsd

This message is used after selecting a room/rate returned from SearchAvailabilityRoom. The message contains the completed room booking structure and is used to create the booking within the system. This message is used to book one room at one property.

### ReviseBooking

Schema File: ReviseBooking\_Request.xsd

This is used to revise details of an existing single-room booking using the booking number or reference. The booking structure also contains comprehensive meta-data, such as indicating which elements of the booking can be amended etc.

### ChangesBooking

Schema File: ChangesBooking\_Request.xsd

This message enables the modification of some fields representative of a reservation

### CancelBooking

Schema File: CancelBooking\_Request.xsd

This message enables the cancellation of a booking

## 1.5.4 Hotels Information

### HotelsList

Schema File: HotelsList\_Request.xsd

This message allows to request the Web Service the list of all featured and active hotels.

## HotelDetails

Schema File: HotelDetail\_Request.xsd

This message allows to request the Web Service all information on hotel's description

## 1.5.5 Errors

The system errors are visualized in standard SOAP:

Example :

```
soapenv:Fault>
    <faultcode>soapenv:Server.userException</faultcode>
    <faultstring>coldfusion.xml.rpc.CFCInvocationException:
[coldfusion.runtime.InvalidListIndexException : Invalid list index 2.]</faultstring>
    <detail>
<ns1:stackTrace xmlns:ns1="http://xml.apache.org/axis/">coldfusion.xml.rpc.CFCInvocationException:
[coldfusion.runtime.InvalidListIndexException : Invalid list index 2.]
    at
coldfusion.xml.rpc.CFComponentSkeleton.__createCFCInvocationException.....
.....
```

The application errors are visualized in the element <Error>. Normally the response content is always in the element <Response>, the subsequent element under the Response contains the type of response. If an application error occurs, in the response message instead of the tag <Response> there will be the tag <Error>. In this element there will be the tag <ErrorCode> with the error code and the tag <ErrorDescription> with the error description. Two examples of comparison between the structure of a message with no returned error and that one with a returned error, as follows :

### Example:

*A concluded transaction with positive outcome*

```
<soapenv:Body>
  <ns1:loginResponse soapenv:encodingStyle="http://schemas.xmlsoap.org/soap/encoding/"
xmlns:ns1="ama">
    <loginReturn xsi:type="ns2:Document" xmlns:ns2="http://xml.apache.org/xml-soap">
      <Response>
        <Login>
          <CompanyName>TEST ADV CR</CompanyName>
          <Token>xxxxxxxxxxxxxxxxxxxxxxxxxxxxxxxx</Token>
          <RatePlanCode>LP2</RatePlanCode>
          <Warning>
            <WarningCode>W0000100</WarningCode>
            <WarningDescription>Login
Successful</WarningDescription>
          </Warning>
        </style>
```

### Example:

A concluded transaction with negative outcome

```
<soapenv:Envelope xmlns:soapenv="http://schemas.xmlsoap.org/soap/envelope/"
xmlns:xsd="http://www.w3.org/2001/XMLSchema" xmlns:xsi="http://www.w3.org/2001/XMLSchema-
instance">
  <soapenv:Body>
    <ns1:loginResponse soapenv:encodingStyle="http://schemas.xmlsoap.org/soap/encoding/"
xmlns:ns1="ama">
      <loginReturn xsi:type="ns2:Document" xmlns:ns2="http://xml.apache.org/xml-soap">
        <Error>
          <ErrorCode>E000101</ErrorCode>
          <ErrorDescription>Login Failed</ErrorDescription>
        </Error>
      </loginReturn>
    </ns1:loginResponse>
  </soapenv:Body>
</soapenv:Envelope>
```

## 2 Login

The client must first login using the **LoginRequest** message before it can do any other transactions. The client is authenticated and if successful, is returned a <AuthenticationToken> that must be included in all subsequent messages for the session.

### 2.1 Login\_request

The client must provide a <login> element that consists of a <Username> and <Password>.

Message structure:

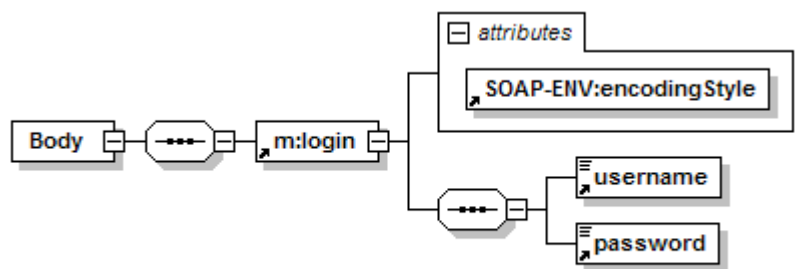

Generated by XMLSpy

www.altova.com

Example (*Login Request.xml*)

```
<SOAP-ENV:Envelope xmlns:SOAP-ENV="http://www.amandatour.com/soap/envelope/" xmlns:SOAP-
ENC="http://schemas.xmlsoap.org/soap/encoding/" xmlns:xsi="http://www.w3.org/2001/XMLSchema-
instance" xmlns:xsd="http://www.w3.org/2001/XMLSchema">
  <SOAP-ENV:Body>
    <m:login xmlns:m="http://amandatour.webservice" SOAP-
ENV:encodingStyle="http://schemas.xmlsoap.org/soap/encoding/">
      <username xsi:type="xsd:string">TESTClient</username>
      <password xsi:type="xsd:string">xxxxxx</password>
    </m:login>
  </SOAP-ENV:Body>
</SOAP-ENV:Envelope>
```

## 2.2 Login\_response

The Web service Amandatour responds to message Login\_request with the message Login\_response.

Message structure:

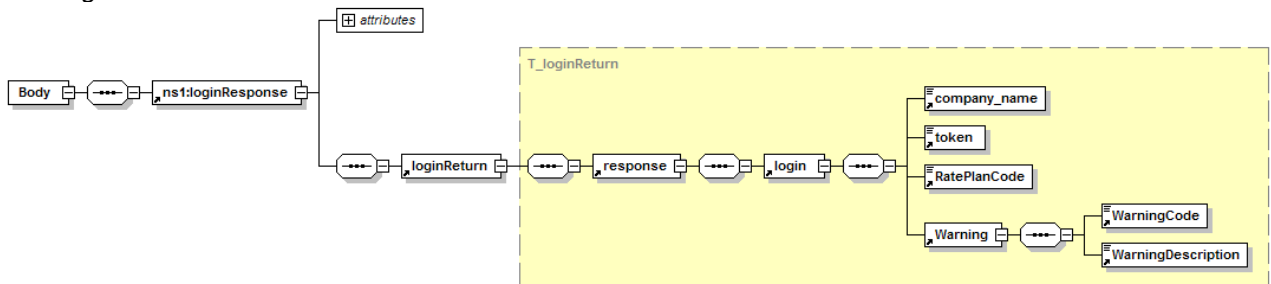

Generated by XMLSpy

www.altova.com

//Response/Login/Company\_name  
Contains the name of the Firm.

//Response/Login/AuthenticationToken  
Contains the authentication string to be included at the beginning of each request message following the Login sent to the Amandatour Web Service.

//Response/Login/RatePlaneCode  
Contains the code relating to the agreed Amandatour Price List.

//Response/Login/Warning  
Message with Login's outcome.

//Response/Login/Warning/WarningCode  
Warning Code

//Response/Login/Warning/WarningDescription  
Warning Description

Example (Login\_Response.xml)

```
<soapenv:Envelope xmlns:soapenv="http://schemas.xmlsoap.org/soap/envelope/"
xmlns:xsd="http://www.w3.org/2001/XMLSchema" xmlns:xsi="http://www.w3.org/2001/XMLSchema-
instance">
  <soapenv:Body>
    <ns1:loginResponse soapenv:encodingStyle="http://schemas.xmlsoap.org/soap/encoding/"
xmlns:ns1="ama">
      <loginReturn xsi:type="ns2:Document" xmlns:ns2="http://xml.apache.org/xml-soap">
        <Response>
          <Login>
            <CompanyName>TEST ADV CR</CompanyName>
            <AuthenticationToken>xxxxxxxxxxxxxxxxxxxxxxxxxxxxxxxxxxxxxxxx</
AuthenticationToken >
            <RatePlanCode>LP2</RatePlanCode>
            <Warning>
              <WarningCode>W0000100</WarningCode>
              <WarningDescription>Login
Successful</WarningDescription>
            </Warning>
          </Login>
        </Response>
      </loginReturn>
    </ns1:loginResponse>
  </soapenv:Body>
</soapenv:Envelope>
```

### 3 AvailabilityList

This message is used to request the hotels list with rooms available in a certain place (city), in a certain period and for a certain number of pax. In addition it is possible to set up other search criteria like "Class", "Name" or hotel's "Code". The Web Service gives back a list of hotels rooms availability for the place, the period and the requested number of pax. A hotel is available (space available) in a certain period for a certain number of pax when the sum of the basic beds plus extra beds is higher or equal to the number of pax.

#### 3.1 AvailabilityList\_Request

This message enables the search of availabilities by following criteria .

Message structure:

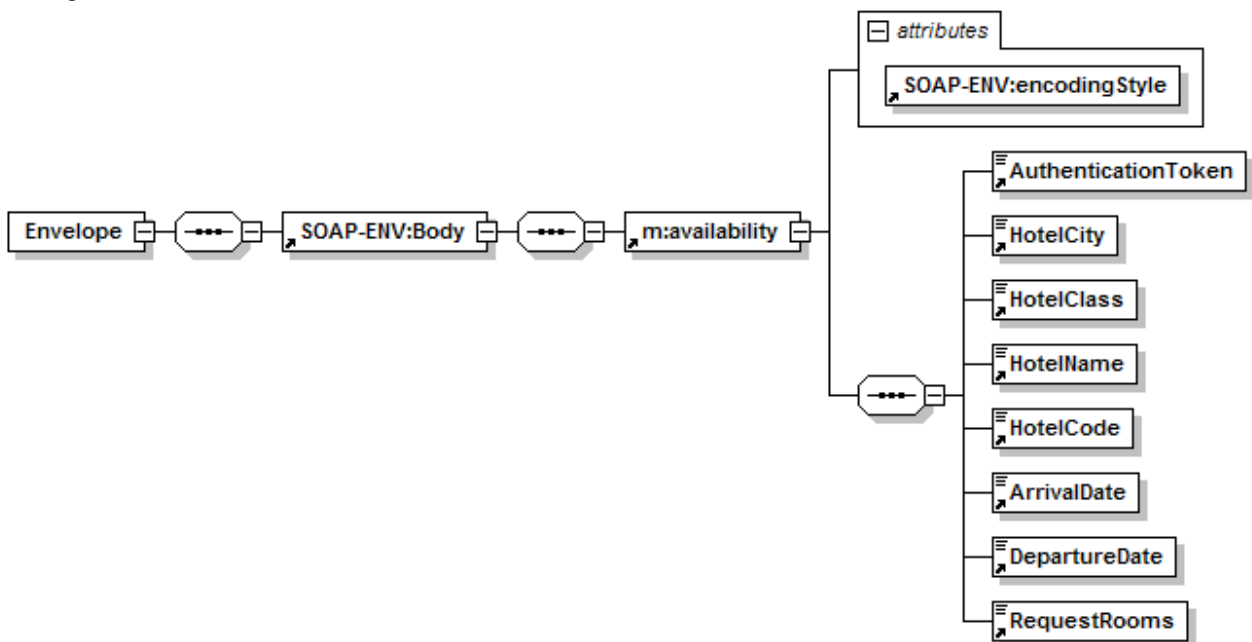

Generated by XMLSpy

www.altova.com

//Availability / **AuthenticationToken**

In this element must be inserted the authentication returned by the "Login\_Response".

//Availability/**Hotel City**

City or Place where hotels are situated. It enables the search of all hotels available situated in the city/place inserted as search criteria. It can be typed even a part of the hotel name and the system shall make the search of all hotels with the inserted string (like %string%).

//Availability/**HotelClass**

It enables the search of all hotels with rooms available belonging to the selected class. The hotels are classified as per following codes:

Class Code	Class Description
*****	5 star
****S	4 star superior
****	4 star
***S	3 star superior
***	3 star
**	2 star

**//Availability/HotelName**

By inserting this selection criteria , the search is narrowed to the single hotel selected.

**//Availability/HotelCode**

As per Amantour's cataloguing.

**//Availability/ArrivalDate**

Date of stay's start.

**//Availability/DepartureDate**

Date of stay's end.

**//Availability/RequestRooms**

Here the request of rooms are inserted. A maximum of 5 rooms each transaction is possible, specifying for each room the number of adults, children with respective age. Such limit (5 rooms) could be increased by an agreement with Amantour. The request consists in creating a values list, separated by "comma" (field separator) and "pipe" (request separator) as per following example:

**1,2,1,9,0,0,0|2,2,0,0,0,0,0|3,2,1,15,0,0,0|4,1,0,0,0,0,0|5,3,0,0,0,0,0**  
**Request Room.1 Request Room.2 Request Room.3 Request Room.4 Request Room.5**

Every room request is separated by the character | (pipe). The request in detail is made up of a list of seven values separated by the character "," (comma).

We take the case of the first request **1,2,1,9,0,0,0** , it's structure is as follows:

- The first value is the request identification number **1**
- The second value is the number of adults to accommodate in the room **2**
- The third value is the number of children to accommodate in the room **1**
- From the fourth to the seventh value should be inserted consecutively the ages of children. A maximum of 4 children can be inserted.

With this first example **1,2,1,9,0,0,0** we see the request for **1** child of **9** years old.

With this second example **1,2,2,7,12,0,0** we see the request for **2** children, the first of **7** years and the second of **12** years old.

Example (AvailabilityList Request.xml)

```
<SOAP-ENV:Envelope xmlns:SOAP-ENV="http://schemas.xmlsoap.org/soap/envelope/" xmlns:SOAP-ENC="http://schemas.xmlsoap.org/soap/encoding/" xmlns:xsi="http://www.w3.org/2001/XMLSchema-instance" xmlns:xsd="http://www.w3.org/2001/XMLSchema">
  <SOAP-ENV:Body>
    <m:availability xmlns:m="ama" SOAP-ENV:encodingStyle="http://schemas.xmlsoap.org/soap/encoding/">
      <AuthenticationToken xsi:type="xsd:string">xxxxxxxxxxxx</AuthenticationToken>
```



```

<HotelCity xsi:type="xsd:string">Roma</HotelCity>
<HotelClass xsi:type="xsd:string"></HotelClass>
<HotelName xsi:type="xsd:string">Regina Hotel Baglioni</HotelName>
<HotelCode xsi:type="xsd:string"></HotelCode>
<ArrivalDate xsi:type="xsd:string">10-01-2008</ArrivalDate>
<DepartureDate xsi:type="xsd:string">10-03-2008</DepartureDate>
<RequestRooms
xsi:type="xsd:string">1,2,1,9,0,0,0|2,2,0,0,0,0|3,2,1,15,0,0|4,1,0,0,0,0|5,3,0,0,0,0</RequestRooms>
  </m:availability>
</SOAP-ENV:Body>
</SOAP-ENV:Envelope>

```

### 3.2 AvailabilityList\_Response

The Web Service gives back a hotels list or just the single hotel with rooms available for the requested place, period and number of pax.

Message structure:

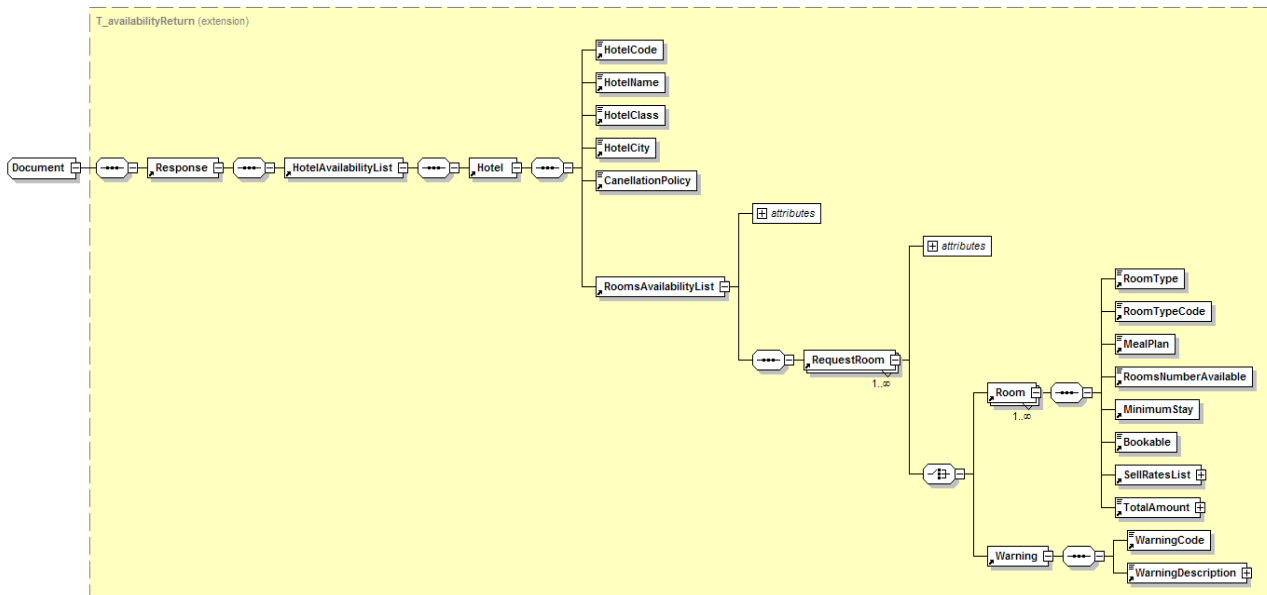

Generated by XMLSpy

www.altova.com

//Response/AvailabilityList/**Hotel**

It contains the identification data as follows:

//Response/AvailabilityList/Hotel/**HotelCode**

Hotel identification code

//Response/AvailabilityList/Hotel/**HotelName**

Hotel name

//Response/AvailabilityList/Hotel/**HotelClass**

Hotel class

//Response/AvailabilityList/Hotel/**HotelCity**

City or place where the hotel is situated

//Response/AvailabilityList/Hotel/**Cancellation Policy**

Cancellation policy

//Response/AvailabilityList /Hotel/**RoomsAvailabilityList**

It contains the list of the available rooms corresponding to the criteria inserted in the message "AvailabilityList\_request".

//Response/ HotelAvailabilityList /Hotel/RoomsAvailabilityList/**Room**

It contains all detailed information on the available room with all daily rates for the requested period, the rate for child, the rate for a possible special offer if applicable, and the total amount for the whole request. The element's structure is as follows:

//Response/ HotelAvailabilityList /Hotel/RoomsAvailabilityList/Room/**RoomType**

Room type description

//Response/ HotelAvailabilityList /Hotel/RoomsAvailabilityList/Room/**RoomTypeCode**

Room type code

//Response/ HotelAvailabilityList /Hotel/RoomsAvailabilityList/Room/**MealsPlan**

Meals plan applied description

Code	Description
<b>BB</b>	Bed & Breakfast
<b>FB</b>	Full Board
<b>RO</b>	Room Only

//Response/ HotelAvailabilityList /Hotel/RoomsAvailabilityList/Room/**RoomsNumberAvailable**

Number of available rooms corresponding to the client demand

//Response/ HotelAvailabilityList /Hotel/RoomsAvailabilityList/Room/**MinimumStay**

It shows the minimum of room nights requested by the hotel to accept the reservation

//Response/ HotelAvailabilityList /Hotel/RoomsAvailabilityList/Room/**Bookable**

Room's availability status. It may contain the following values:

- SPACE AVAILABLE
- ON REQUEST

At present the Amantour Web Service visualizes the element's details <Room> only if the room is available, otherwise it responds "Warning"

Example:

```
<RequestRoom reqAdults="3" reqChildren="0" reqID="5">
  <Warning>
    <WarningCode>W000000010 8 2</WarningCode>
    <WarningDescription languageCode="eng">Accommodations not available for the search
criteria you entered for [Request Room No.5 adults=3][ListValueRequestRooms =
1,2,1,9,0,0,0|2,2,0,0,0,0,0|3,2,1,15,0,0|4,1,0,0,0,0,0|5,3,0,0,0,0,0]
    </WarningDescription>
  </Warning>
</RequestRoom>
```

Therefore, at present, the ON REQUEST status, that is the possibility to make a request with subsequent confirmation is not available. To activate such function is necessary an agreement with Amantour

//Response/ HotelAvailabilityList /RoomsAvailabilityList/Room/**SellRatesList**

*Attributes:*

- occurs="number of repetitions of the daily room rates"
- 

It contains in repetitive manner the daily room rates for the requested period

//Response/ HotelAvailabilityList /RoomsAvailabilityList/Room/SellRatesList /**RoomSellRate**

It contains the room rate for the day indicated in the attribute "date"

*Attributes.*

- date="Daily room rate "
- dayOfTheWeek= [Sun,Mon,Tue,Wed,Thu,Fri,Sat]
- sequence= "progressive "
- rateFrequency= [daily , weekly, Package5days, Package10days, Package15days, ecc.]
- typeFare=[midweek,weekend].

//Response/ HotelAvailabilityList /RoomsAvailabilityList/Room/**TotalAmount**

It contains the calculation of the room selling total price as per inserted criteria

//Response/ HotelAvailabilityList /RoomsAvailabilityList/Room/TotalAmount/**ArrivalDate/**

Date of stay's start [mm-dd-yyyy]

//Response/ HotelAvailabilityList /RoomsAvailabilityList/Room/TotalAmount/**DepartureDate/**

Date of stay's end [mm-dd-yyyy]

//Response/ HotelAvailabilityList /RoomsAvailabilityList/Room/TotalAmount/**NightsNumber/**

Number of requested nights

//Response/ HotelAvailabilityList /RoomsAvailabilityList/Room/TotalAmount/**RoomTotalAmount/**

Total room price for the whole requested stay

//Response/HotelAvailabilityList /RoomsAvailabilityList/Room/**Children**

It contains the calculation for one or more children for the whole requested

//Response/HotelAvailabilityList /RoomsAvailabilityList/Room/Children/**RequiredChildren**

Number of requested children

//Response/HotelAvailabilityList /RoomsAvailabilityList/Room/Children/**ChildAge**

Child age

*Attributes*

- ID=" identification number of the child age as per request made in the tag <RequiredChildren>.

Example:

```
<Children>
  <RequiredChildren>2</RequiredChildren>
  <ChildAge ID="1">9</ChildAge>
  <ChildAge ID="2">13</ChildAge>
  <ChildTotalAmount>108</ ChildTotalAmount >
</Children>
```

//Response/HotelAvailabilityList /RoomsAvailabilityList/Room/Children/RequiredChildren/**ChildTotalAmount**

Children's total price calculation for the whole requested stay

//Response/HotelAvailabilityList /RoomsAvailabilityList/Room/**SpecialOffer**

Special offer description if applicable to the requested stay's period

//Response/HotelAvailabilityList /RoomsAvailabilityList/Room/SpecialOffer/**SpecialOfferDiscount**

Total amount to be discounted on the rooms total selling price for the whole requested stay

//Response/HotelAvailabilityList /RoomsAvailabilityList/Room/SpecialOffer/**SpecialOfferChildDiscount**

Total amount to be discounted on the rooms total selling price for the whole children requested stay

//Response/HotelAvailabilityList /RoomsAvailabilityList/Room/**TotalAmount**

Total rooms selling price

Example (AvailabilityList Response.xml)

```
<soapenv:Envelope xmlns:soapenv="http://schemas.xmlsoap.org/soap/envelope/" xmlns:xsd="http://www.w3.org/2001/XMLSchema"
xmlns:xsi="http://www.w3.org/2001/XMLSchema-instance">
  <soapenv:Body>
    <ns1:availabilityResponse soapenv:encodingStyle="http://schemas.xmlsoap.org/soap/encoding/"
xmlns:ns1="ama">
      <availabilityReturn xsi:type="ns2:Document" xmlns:ns2="http://xml.apache.org/xml-soap">
        <Response>
          <HotelAvailabilityList>
            <Hotel>
              <HotelCode>ROM35</HotelCode>
              <HotelName>REGINA HOTEL BAGLIONI</HotelName>
              <HotelClass>*****</HotelClass>
              <HotelCity>Roma</HotelCity>
              <HotelContractType>F</HotelContractType>
              <CanellationPolicy>01-01-2008-12-31-2008 : between 48 hours
and check-in: penalty 1 room night;</CanellationPolicy>
            <RoomsAvailabilityList
listValReqRooms="1,2,1,9,0,0,0|2,2,0,0,0,0,0|3,2,1,15,0,0|4,1,0,0,0,0|5,3,0,0,0,0" totRoomsReqPerPax="1,3,1,0,0">
              <RequestRoom reqAdults="2" reqChildren="1"
reqID="1">
                <Room>
                  <RoomType>DOUBLE
CLASSIC</RoomType>
                  <RoomTypeCode>DB
CLA</RoomTypeCode>
                  <MealPlan>bed & amp;
breakfast</MealPlan>
                <RoomsNumberAvailable>3</RoomsNumberAvailable>
                <MinimumStay/>
                <Bookable>SPACE
AVAILABLE</Bookable>
                <SellRatesList occurs="2">
                  <RoomSellRate
currencyCode="EUR" date="10-01-2008" dayOfTheWeek="Wed" rateFrequency="Daily" sequence="1"
typeFare="midweek">398.00</RoomSellRate>
                  <RoomSellRate
currencyCode="EUR" date="10-02-2008" dayOfTheWeek="Thu" rateFrequency="Daily" sequence="2"
typeFare="midweek">398.00</RoomSellRate>
                </SellRatesList>
                <TotalAmount>
                  <ArrivalDate>10-01-
2008</ArrivalDate>
                  <DepartureDate>10-03-
2008</DepartureDate>
                  <NightsNumber>2</NightsNumber>
                  <RoomQuantity>1</RoomQuantity>
                  <RoomTotalAmount
currencyCode="EUR">796.00</RoomTotalAmount>
                  <Children>
                    <RequiredChildren>1</RequiredChildren>
                    <ChildAge
ID="1">9</ChildAge>
                    <ChildFree>Yes</ChildFree>
                    <ChildrenPolicy>
                      <Discount valueType="%">100</Discount>
                    </ChildrenPolicy>
                    <ChildTotalAmount currencyCode="EUR">0.00</ChildTotalAmount>
                  </Children>
                  <SpecialOfferDiscount
currencyCode="EUR">0.00</SpecialOfferDiscount>
                  <SpecialOfferChildDiscount currencyCode="EUR">0.00</SpecialOfferChildDiscount>
```

```

currencyCode="EUR">796.00</TotalAmount>
    <ChildDebug>2,1,9,0,0,0,</ChildDebug>
    <TotalAmount>
</Room>
<Room>
    <RoomType>DOUBLE
    <RoomTypeCode>DB
    <MealPlan>bed & amp;
    <RoomsNumberAvailable>3</RoomsNumberAvailable>
    <MinimumStay/>
    <Bookable>SPACE
    <SellRatesList occurs="2">
        <RoomSellRate
currencyCode="EUR" date="10-01-2008" dayOfTheWeek="Wed" rateFrequency="Daily" sequence="1"
typeFare="midweek">452.00</RoomSellRate>
        <RoomSellRate
currencyCode="EUR" date="10-02-2008" dayOfTheWeek="Thu" rateFrequency="Daily" sequence="2"
typeFare="midweek">452.00</RoomSellRate>
    </SellRatesList>
    <TotalAmount>
        <ArrivalDate>10-01-
        <DepartureDate>10-03-
    2008</ArrivalDate>
    2008</DepartureDate>
    <NightsNumber>2</NightsNumber>
    <RoomQuantity>1</RoomQuantity>
    <RoomTotalAmount
currencyCode="EUR">904.00</RoomTotalAmount>
    <Children>
    <RequiredChildren>1</RequiredChildren>
    <ChildAge
ID="1">9</ChildAge>
    <ChildFree>Yes</ChildFree>
    <ChildrenPolicy>
    <Discount valueType="%">100</Discount>
    </ChildrenPolicy>
    <ChildTotalAmount currencyCode="EUR">0.00</ChildTotalAmount>
    <Children>
    <SpecialOfferDiscount
currencyCode="EUR">0.00</SpecialOfferDiscount>
    <SpecialOfferChildDiscount currencyCode="EUR">0.00</SpecialOfferChildDiscount>
    <TotalAmount
currencyCode="EUR">904.00</TotalAmount>
    <ChildDebug>2,1,9,0,0,0,</ChildDebug>
    <TotalAmount>
</Room>
</RequestRoom>
<RequestRoom reqAdults="2" reqChildren="0"
reqID="2">
    <Room>
    <RoomType>DOUBLE
    <RoomTypeCode>DB
    <MealPlan>bed & amp;
    <RoomsNumberAvailable>3</RoomsNumberAvailable>
    <MinimumStay/>

```

AVAILABLE</Bookable>	<Bookable>SPACE
	<SellRatesList occurs="2">
	<RoomSellRate
currencyCode="EUR" date="10-01-2008" dayOfTheWeek="Wed" rateFrequency="Daily" sequence="1"	
typeFare="midweek">398.00</RoomSellRate>	
	<RoomSellRate
currencyCode="EUR" date="10-02-2008" dayOfTheWeek="Thu" rateFrequency="Daily" sequence="2"	
typeFare="midweek">398.00</RoomSellRate>	
	</SellRatesList>
	<TotalAmount>
2008</ArrivalDate>	<ArrivalDate>10-01-
2008</DepartureDate>	<DepartureDate>10-03-
<NightsNumber>2</NightsNumber>	
<RoomQuantity>1</RoomQuantity>	
currencyCode="EUR">796.00</RoomTotalAmount>	<RoomTotalAmount
	<Children>
<RequiredChildren>0</RequiredChildren>	
<ChildTotalAmount currencyCode="EUR">0.00</ChildTotalAmount>	
	</Children>
currencyCode="EUR">0.00</SpecialOfferDiscount>	<SpecialOfferDiscount
<SpecialOfferChildDiscount currencyCode="EUR">0.00</SpecialOfferChildDiscount>	
currencyCode="EUR">796.00</TotalAmount>	<TotalAmount
<ChildDebug>2,0,0,0,0,0,</ChildDebug>	
	</TotalAmount>
	</Room>
	<Room>
DELUXE</RoomType>	<RoomType>DOUBLE
DELUXE</RoomTypeCode>	<RoomTypeCode>DB
breakfast</MealPlan>	<MealPlan>bed & amp;
<RoomsNumberAvailable>3</RoomsNumberAvailable>	
	<MinimumStay/>
AVAILABLE</Bookable>	<Bookable>SPACE
	<SellRatesList occurs="2">
	<RoomSellRate
currencyCode="EUR" date="10-01-2008" dayOfTheWeek="Wed" rateFrequency="Daily" sequence="1"	
typeFare="midweek">452.00</RoomSellRate>	
	<RoomSellRate
currencyCode="EUR" date="10-02-2008" dayOfTheWeek="Thu" rateFrequency="Daily" sequence="2"	
typeFare="midweek">452.00</RoomSellRate>	
	</SellRatesList>
	<TotalAmount>
2008</ArrivalDate>	<ArrivalDate>10-01-
2008</DepartureDate>	<DepartureDate>10-03-
<NightsNumber>2</NightsNumber>	
<RoomQuantity>1</RoomQuantity>	
currencyCode="EUR">904.00</RoomTotalAmount>	<RoomTotalAmount
	<Children>
<RequiredChildren>0</RequiredChildren>	
<ChildTotalAmount currencyCode="EUR">0.00</ChildTotalAmount>	
	</Children>
currencyCode="EUR">0.00</SpecialOfferDiscount>	<SpecialOfferDiscount

```

        <SpecialOfferChildDiscount currencyCode="EUR">0.00</SpecialOfferChildDiscount>
currencyCode="EUR">904.00</TotalAmount>
        <ChildDebug>2,0,0,0,0,0,</ChildDebug>
reqID="3">
CLASSIC</RoomType>
CLA</RoomTypeCode>
breakfast</MealPlan>
        <RoomsNumberAvailable>3</RoomsNumberAvailable>
AVAILABLE</Bookable>
currencyCode="EUR" date="10-01-2008" dayOfTheWeek="Wed" rateFrequency="Daily" sequence="1"
typeFare="midweek">398.00</RoomSellRate>
currencyCode="EUR" date="10-02-2008" dayOfTheWeek="Thu" rateFrequency="Daily" sequence="2"
typeFare="midweek">398.00</RoomSellRate>
2008</ArrivalDate>
2008</DepartureDate>
        <NightsNumber>2</NightsNumber>
        <RoomQuantity>1</RoomQuantity>
currencyCode="EUR">796.00</RoomTotalAmount>
        <RequiredChildren>1</RequiredChildren>
ID="1">15</ChildAge>
        <ChildTotalAmount currencyCode="EUR">108.00</ChildTotalAmount>
currencyCode="EUR">0.00</SpecialOfferDiscount>
        <SpecialOfferChildDiscount currencyCode="EUR">0.00</SpecialOfferChildDiscount>
currencyCode="EUR">904.00</TotalAmount>
        <ChildDebug>2,1,15,0,0,</ChildDebug>
DELUXE</RoomType>
DELUXE</RoomTypeCode>
breakfast</MealPlan>
        <RoomsNumberAvailable>3</RoomsNumberAvailable>
AVAILABLE</Bookable>
currencyCode="EUR" date="10-01-2008" dayOfTheWeek="Wed" rateFrequency="Daily" sequence="1"
typeFare="midweek">452.00</RoomSellRate>

```

```

</TotalAmount>
</Room>
</RequestRoom>
<RequestRoom reqAdults="2" reqChildren="1"
</Room>
<RoomType>DOUBLE
<RoomTypeCode>DB
<MealPlan>bed & amp;
<MinimumStay/>
<Bookable>SPACE
<SellRatesList occurs="2">
<RoomSellRate
<RoomSellRate
</SellRatesList>
<TotalAmount>
<ArrivalDate>10-01-
<DepartureDate>10-03-
<RoomTotalAmount
<Children>
<ChildAge
</Children>
<SpecialOfferDiscount
</TotalAmount>
</TotalAmount>
</Room>
<Room>
<RoomType>DOUBLE
<RoomTypeCode>DB
<MealPlan>bed & amp;
<MinimumStay/>
<Bookable>SPACE
<SellRatesList occurs="2">
<RoomSellRate

```

```

currencyCode="EUR" date="10-02-2008" dayOfTheWeek="Thu" rateFrequency="Daily" sequence="2"
typeFare="midweek">452.00</RoomSellRate>
</SellRatesList>
</TotalAmount>
2008</ArrivalDate>
2008</DepartureDate>
<NightsNumber>2</NightsNumber>
<RoomQuantity>1</RoomQuantity>
currencyCode="EUR">904.00</RoomTotalAmount>
<Children>
<RequiredChildren>1</RequiredChildren>
<ChildAge
ID="1">15</ChildAge>
<ChildTotalAmount currencyCode="EUR">108.00</ChildTotalAmount>
</Children>
<SpecialOfferDiscount
currencyCode="EUR">0.00</SpecialOfferDiscount>
<SpecialOfferChildDiscount currencyCode="EUR">0.00</SpecialOfferChildDiscount>
</SpecialOfferDiscount>
currencyCode="EUR">1012.00</TotalAmount>
<ChildDebug>2,1,15,0,0,</ChildDebug>
</TotalAmount>
</Room>
</RequestRoom>
<RequestRoom reqAdults="1" reqChildren="0"
reqID="4">
<Room>
<RoomType>SINGLE
<RoomTypeCode>SG
<MealPlan>bed & amp;
breakfast</MealPlan>
<RoomsNumberAvailable>3</RoomsNumberAvailable>
<MinimumStay/>
<Bookable>SPACE
AVAILABLE</Bookable>
<SellRatesList occurs="2">
<RoomSellRate
currencyCode="EUR" date="10-01-2008" dayOfTheWeek="Wed" rateFrequency="Daily" sequence="1"
typeFare="midweek">285.00</RoomSellRate>
<RoomSellRate
currencyCode="EUR" date="10-02-2008" dayOfTheWeek="Thu" rateFrequency="Daily" sequence="2"
typeFare="midweek">285.00</RoomSellRate>
</SellRatesList>
</TotalAmount>
2008</ArrivalDate>
2008</DepartureDate>
<NightsNumber>2</NightsNumber>
<RoomQuantity>1</RoomQuantity>
currencyCode="EUR">570.00</RoomTotalAmount>
<Children>
<RequiredChildren>0</RequiredChildren>
<ChildTotalAmount currencyCode="EUR">0.00</ChildTotalAmount>
</Children>
<SpecialOfferDiscount
currencyCode="EUR">0.00</SpecialOfferDiscount>
<SpecialOfferChildDiscount currencyCode="EUR">0.00</SpecialOfferChildDiscount>

```



```

currencyCode="EUR">570.00</TotalAmount>
    <ChildDebug>1,0,0,0,0,0,</ChildDebug>
    <TotalAmount>
    </Room>
    <Room>
    <RoomType>DOUBLE DELUXE
    <RoomTypeCode>DUS
    <MealPlan>bed & amp;
    <RoomsNumberAvailable>3</RoomsNumberAvailable>
    <MinimumStay/>
    <Bookable>SPACE
    <SellRatesList occurs="2">
    <RoomSellRate
    <RoomSellRate
    <SellRatesList>
    <TotalAmount>
    <ArrivalDate>10-01-
    <DepartureDate>10-03-
    <RoomTotalAmount
    <Children>
    <RequiredChildren>0</RequiredChildren>
    <ChildTotalAmount currencyCode="EUR">0.00</ChildTotalAmount>
    <Children>
    <SpecialOfferDiscount
    <SpecialOfferChildDiscount currencyCode="EUR">0.00</SpecialOfferChildDiscount>
    <TotalAmount
    <TotalAmount
    <ChildDebug>1,0,0,0,0,0,</ChildDebug>
    <TotalAmount>
    </Room>
    <RequestRoom>
    <RequestRoom reqAdults="3" reqChildren="0"
    <Warning>
    <WarningCode>W00000010
    <WarningDescription
    languageCode="eng">Accommodations not available for the search criteria you entered for [Request Room No.5
    adults=3][ListValueRequestRooms = 1,2,1,9,0,0,0|2,2,0,0,0,0,0|3,2,1,15,0,0,0|4,1,0,0,0,0,0|5,3,0,0,0,0,0] </WarningDescription>
    <Warning>
    </RequestRoom>
    </RoomsAvailabilityList>
    </Hotel>
    </HotelAvailabilityList>
    </Response>
    </availabilityReturn>
    </ns1:availabilityResponse>
    </soapenv:Body>
</soapenv:Envelope>

```

## 4 Booking

This message enables to book one room returned available in the "AvailabilityList\_Response"

### 4.1 MakeBooking\_Request

Message structure:

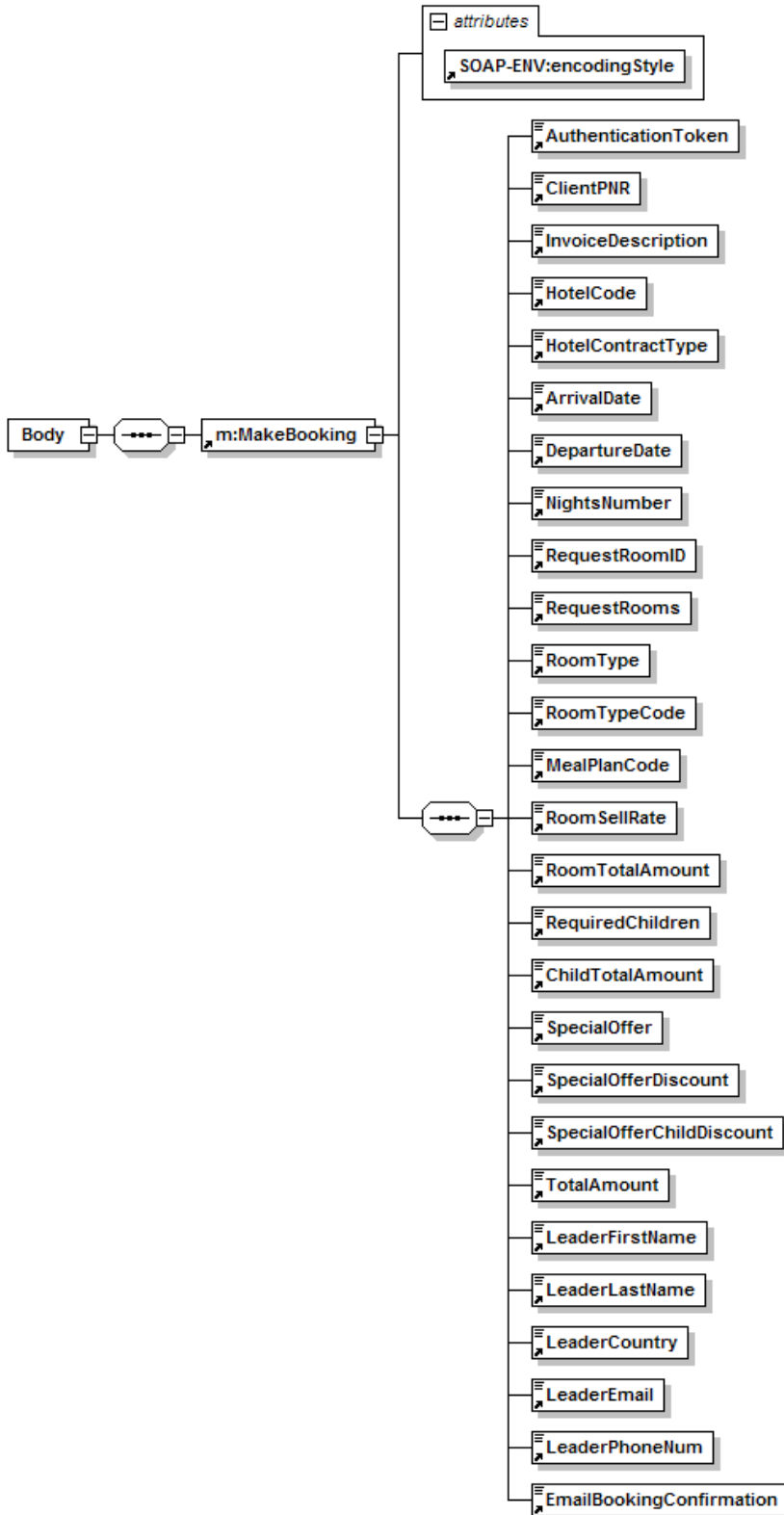

//MakeBooking/ **AuthenticationToken**

In this element must be inserted the authentication returned by the “Login\_Response”. If a wrong token is inserted the system answers with the following error :

```
<Error>  
  <ErrorCode>E000101</ErrorCode>  
  <ErrorDescription>Login Failed</ErrorDescription>  
</Error>
```

By sending the MakeBooking\_request, the Web Service makes a new check on rooms availability, in case of negative reply to the request, the Web Service responds with the message MakeBooking\_response as per following error structure :

```
<Error>  
  <ErrorCode>E000415</ErrorCode>  
  <ErrorDescription> The room is no longer available for this reservation </ErrorDescription>  
</Error>
```

//MakeBooking/**ClientPNR**

File reference number of Client's system.

//MakeBooking/**InvoiceDescription**

Description of the order that will be mentioned in the invoice issued by Amandatour.

//MakeBooking/ **HotelCode**

Hotel identification code returned by the message “AvailabilityList\_Response”.

//MakeBooking/ **HotelContractType**

Hotel contract type returned by the message “AvailabilityList\_Response”.

//MakeBooking/**ArrivalDate**

Date of stay's start (mm-dd-yyyy).

//MakeBooking/**DepartureDate**

Date of stay's end (mm-dd-yyyy).

//MakeBooking/**NightsNumber**

Nights Numer of stay's.

//MakeBooking/**RequestRoomID**

Identification number of rooms request inserted in the message “AvailabilityList\_Request” and returned by the message AvailabilityList\_Response.

//MakeBooking/**RequestRooms**

This element contains the request in detail is made up of a list of seven values separated by the character “,” (comma).

Example. *RequestRooms* structure

1,2,1,9,0,0,0

- The first value is the request identification number **1**
- The second value is the number of adults to accomodate in the room **2**
- The third value is the number of children to accommodate in the room **1**
- From the fourth to the seventh value should be inserted consecutively the ages of children. A maximum of 4 children can be inserted.

**//MakeBooking/RoomType**

Type of room returned by the message "AvailabilityList\_Response".

**//MakeBooking/RoomTypeCode**

Code of the room type returned by the message "AvailabilityList\_Response".

**//MakeBooking/MealPlaneCode**

Code of the meals plan applied to the room returned by the message "AvailabilityList\_Response".

**//MakeBooking/RoomSellRate**

Room selling selling price applied to the first day of stay returned by the message "AvailabilityList\_Response".

**//MakeBooking/RoomTotalAmount**

Total room price for the whole requested stay returned by the message "AvailabilityList\_Response".

**//MakeBooking/RequiredChildren**

Number of requested children in the message "AvailabilityList\_Request". If no children have been requested, insert the element with 0 value.

**//MakeBooking/ChildTotalAmount**

Children total selling price for the whole requested stay returned by the message "AvailabilityList\_Response".

If no children have been requested, insert the element with 0 value.

**//MakeBooking/SpecialOffer**

Description of the special offer returned by the message "AvailabilityList\_Response". If no special offer has been applied, insert the element with "null" value.

**//MakeBooking/SpecialOfferDiscount**

Total amount to be discounted on the rooms total selling price for the whole requested stay returned by the message AvailabilityList\_Response. If any amount of discount returned, insert the element with 0 value.

**//MakeBooking/SpecialOfferChildDiscount**

Total amount to be discounted on the rooms total selling price for the whole children requested stay returned by the message AvailabilityList\_Response. If any amount of discount returned, insert the element with 0 value.

**//MakeBooking/TotalAmount**

Total amount of reserved rooms returned by the message "AvailabilityList\_Response".

**//MakeBooking/LeaderFirstName**

Name of the reference pax.

**//MakeBooking/LeaderLastName**

Surname of the reference pax.

**//MakeBooking/CountryName**

Reference pax country of origin.

**//MakeBooking/LeaderEmail**

Reference pax e-mail.

**//MakeBooking/LeaderPhoneNum**

Reference pax telephone number.

**//MakeBooking/EmailBookingConfirmation**

E-mail address of the Web Service Client/user for the pro-forma invoice sending (Booking Confirmation).

### Example (*MakeBooking Request.xml*)

```
<SOAP-ENV:Envelope xmlns:SOAP-ENV="http://schemas.xmlsoap.org/soap/envelope/" xmlns:SOAP-ENC="http://schemas.xmlsoap.org/soap/encoding/" xmlns:xsi="http://www.w3.org/2001/XMLSchema-instance" xmlns:xsd="http://www.w3.org/2001/XMLSchema">
  <SOAP-ENV:Body>
    <m:MakeBooking xmlns:m="ama" SOAP-ENV:encodingStyle="http://schemas.xmlsoap.org/soap/encoding/">
      <AuthenticationToken xsi:type="xsd:string">xxxxxxxxxxxx</AuthenticationToken>
      <ClientPNR xsi:type="xsd:string">P001</ClientPNR>
      <HotelCode xsi:type="xsd:string">ROM35</HotelCode>
      <ArrivalDate xsi:type="xsd:string">10-01-2008</ArrivalDate>
      <DepartureDate xsi:type="xsd:string">10-03-2008</DepartureDate>
      <NightsNumber xsi:type="xsd:double">2</NightsNumber>
      <RequestRoomID xsi:type="xsd:string">1</RequestRoomID>
      <RequestRooms xsi:type="xsd:string">1,2,1,9,0,0,0</RequestRooms>
      <RoomType xsi:type="xsd:string">DOUBLE CLASSIC</RoomType>
      <RoomTypeCode xsi:type="xsd:string">DB CLA</RoomTypeCode>
      <MealPlanCode xsi:type="xsd:string">BB</MealPlanCode>
      <RoomSellRate xsi:type="xsd:double">398.00</RoomSellRate>
      <RoomTotalAmount xsi:type="xsd:double">796.00</RoomTotalAmount>
      <RequiredChildren xsi:type="xsd:double">1</RequiredChildren>
      <ChildTotalAmount xsi:type="xsd:double">0.00</ChildTotalAmount>
      <SpecialOffer xsi:type="xsd:string"></SpecialOffer>
      <SpecialOfferDiscount xsi:type="xsd:double">0.00</SpecialOfferDiscount>
      <SpecialOfferChildDiscount xsi:type="xsd:double">0.00</SpecialOfferChildDiscount>
      <TotalAmount xsi:type="xsd:double">796.00</TotalAmount>
      <LeaderFirstName xsi:type="xsd:string">Joe</LeaderFirstName>
      <LeaderLastName xsi:type="xsd:string">Citizen</LeaderLastName>
      <LeaderCountry xsi:type="xsd:string">England</LeaderCountry>
      <LeaderEmail xsi:type="xsd:string">joe@eng.uk</LeaderEmail>
      <LeaderPhoneNum xsi:type="xsd:string">1123455566</LeaderPhoneNum>
      <EmailBookingConfirmation xsi:type="xsd:string">booking@client.com</EmailBookingConfirmation>
    </m:MakeBooking>
  </SOAP-ENV:Body>
</SOAP-ENV:Envelope>
```

## 4.2 MakeBooking\_Response

On a booking request, the Web Service responds with a message (MakeBooking\_response) which will inform to the Client the confirmation or refusal. Subsequently, in the moment in which a MakeBooking\_request is sent, the Web Service makes again a new check on rooms availability, in case of negative reply to the request, the Web Service responds with the message MakeBooking\_response with the following error :

```
<Error>
  <ErrorCode>E000200</ErrorCode>
  <ErrorDescription> Rooms not available for reservation request </ErrorDescription>
</Error>
```

Message structure :

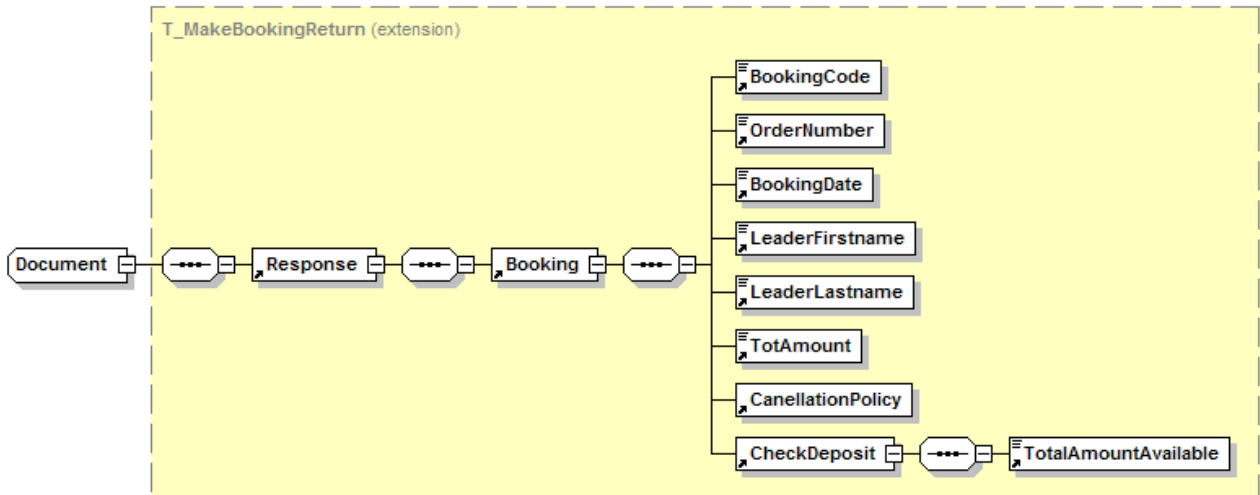

Generated by XMLSpy

www.altova.com

//Response/MakeBooking/Booking/**Booking Code**  
 Identification booking code released by Amandatour

//Response/MakeBooking/Booking/**BookingOrderNumber**  
 Order number released by Amandatour. Such order number will be included as reference in the invoice to be sent by Amandatour to the Web Service Client/user

//Response/MakeBooking/Booking/**Booking Date**  
 Date when has been executed and confirmed the booking by Amandatour

//Response/MakeBooking/Booking//**LeaderFirstName**  
 Name of the reference pax

//Response/MakeBooking/Booking/**LeaderLastName**  
 Surname of the reference pax

//Response/MakeBooking/Booking/**TotalAmountAccommodation**  
 Total amount of reserved rooms

//Response/MakeBooking/Booking/**CancellationPolicy**  
 Cancellation policy reference in case of Client cancellation

//Response/MakeBooking/Booking/**CheckDeposit**/  
 It contains information on the deposit amount paid by the Client. The element's structure as follows :

<TotalAmountAvailable>  
 Client deposit total amount. If the total amount of all reservations requested by the Client is higher than the deposit amount paid , the Web Service responds with the following "Warning" :

```

    <CheckDeposit>
      <Warning>
        <WarningCode>W0000203</WarningCode>
        <WarningDescription> Deposit finished</WarningDescription>
      </Warning>
    </CheckDeposit>
  
```

Example (MakeBooking\_Response.xml)

```

    <soapenv:Envelope xmlns:soapenv="http://schemas.xmlsoap.org/soap/envelope/"
    xmlns:xsd="http://www.w3.org/2001/XMLSchema" xmlns:xsi="http://www.w3.org/2001/XMLSchema-
    instance">
      <soapenv:Body>
  
```

```
<ns1:MakeBookingResponse
soapenv:encodingStyle="http://schemas.xmlsoap.org/soap/encoding/" xmlns:ns1="ama">
  <MakeBookingReturn xsi:type="ns2:Document"
xmlns:ns2="http://xml.apache.org/xml-soap">
    <Response>
      <Booking>
        <BookingCode>999988252</BookingCode>
        <OrderNumber>50349/2008</OrderNumber>
        <BookingDate>07-27-2008</BookingDate>
        <LeaderFirstname>Joe</LeaderFirstname>
        <LeaderLastname>Citizen</LeaderLastname>
        <TotAmount currencyCode="EUR">796.00</TotAmount>
        <CanellationPolicy>01-01-2008-12-31-2008 : between 48
hours and check-in: penalty 1 room night;</CanellationPolicy>
        <CheckDeposit>
          <TotalAmountAvailable>10000.00</TotalAmountAvailable>
          </CheckDeposit>
        </Booking>
      </Response>
    </MakeBookingReturn>
  </ns1:MakeBookingResponse>
</soapenv:Body>
</soapenv:Envelope>
```

### 4.3 ReviseBooking\_Request

It enables to request to the Web Service the list of reservations made. It is possible to search one or more reservations by the following criteria : Date of generating order (Booking Date), Client reservation reference number (ClientPNR), Booking Code (Booking Code).

Message Structure:

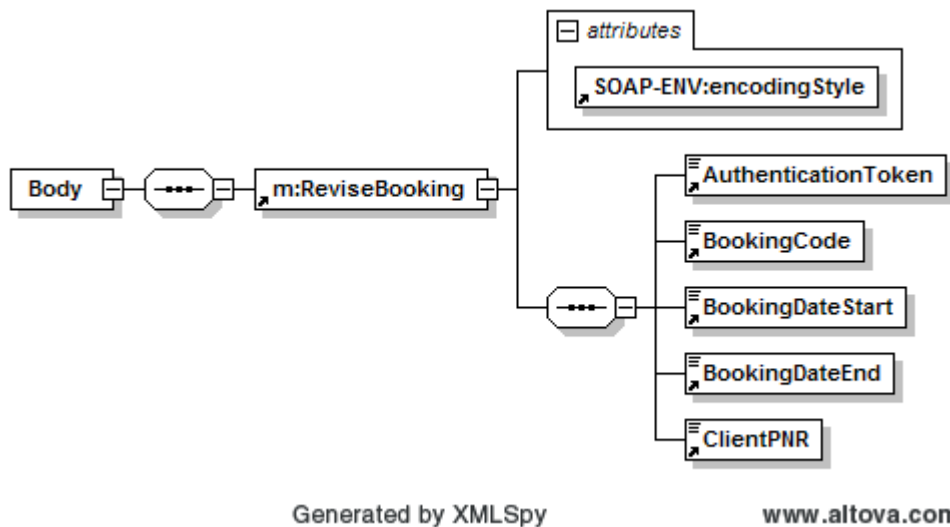

#### //ReviseBooking/**AuthenticationToken**

In this element must be inserted the authentication token returned by the "Login\_Response". If a wrong token is inserted, the system responds with following error :

```
<Error>  
  <ErrorCode>E000101</ErrorCode>  
  <ErrorDescription>Login Failed</ErrorDescription>  
</Error>
```

#### //ReviseBooking/**BookingCode**

Booking identification code returned by the message "MakeBooking\_Response". By entering such criterion , only the data of the booking corresponding to the inserted request code will be returned

#### //ReviseBooking/**BookingDateStart**

The date from when the search should start. The date is that one of the generated order. The result is a list of the generated order with a date >= of the date inserted in the request

#### //ReviseBooking/**BookingDataStart**

The date when the search should end. The date is that one of the generated order. The result is a list of the generated order with a date <= of the date inserted in the request



//ReviseBooking/ClientPNR  
File reference number of Client's system

.Example (ReviseBooking Request.xml)

```
<SOAP-ENV:Envelope xmlns:SOAP-ENV="http://schemas.xmlsoap.org/soap/envelope/" xmlns:SOAP-ENC="http://schemas.xmlsoap.org/soap/encoding/" xmlns:xsi="http://www.w3.org/2001/XMLSchema-instance" xmlns:xsd="http://www.w3.org/2001/XMLSchema">
  <SOAP-ENV:Body>
    <m:MakeBooking xmlns:m="ama" SOAP-ENV:encodingStyle="http://schemas.xmlsoap.org/soap/encoding/">
      <AuthenticationToken xsi:type="xsd:string"> xxxxxxxxxxxxxx </AuthenticationToken>
      <BookingCode xsi:type="xsd:double">99999456</BookingCode>
      <BookingDateStart xsi:type="xsd:string">07-15-2008</BookingDateStart>
      <BookingDateEnd xsi:type="xsd:string">08-15-2008</BookingDateEnd>
      <ClientPNR xsi:type="xsd:string"></ClientPNR>
    </m:MakeBooking>
  </SOAP-ENV:Body>
</SOAP-ENV:Envelope>
```

## 4.4 ReviseBooking\_Response

This message returns the list of reservations made by the clients and selected according to the search criteria inserted in the request message "ReviseBooking\_Request". If there is no booking according to such inserted criteria , the Web Service responds with following error :

```
<Error>
  <ErrorCode>E000201</ErrorCode>
  <ErrorDescription> Booking not found </ErrorDescription>
</Error>
```

In case of positive search result, the details will be included in the element **<BookingList>**

Message Structure:

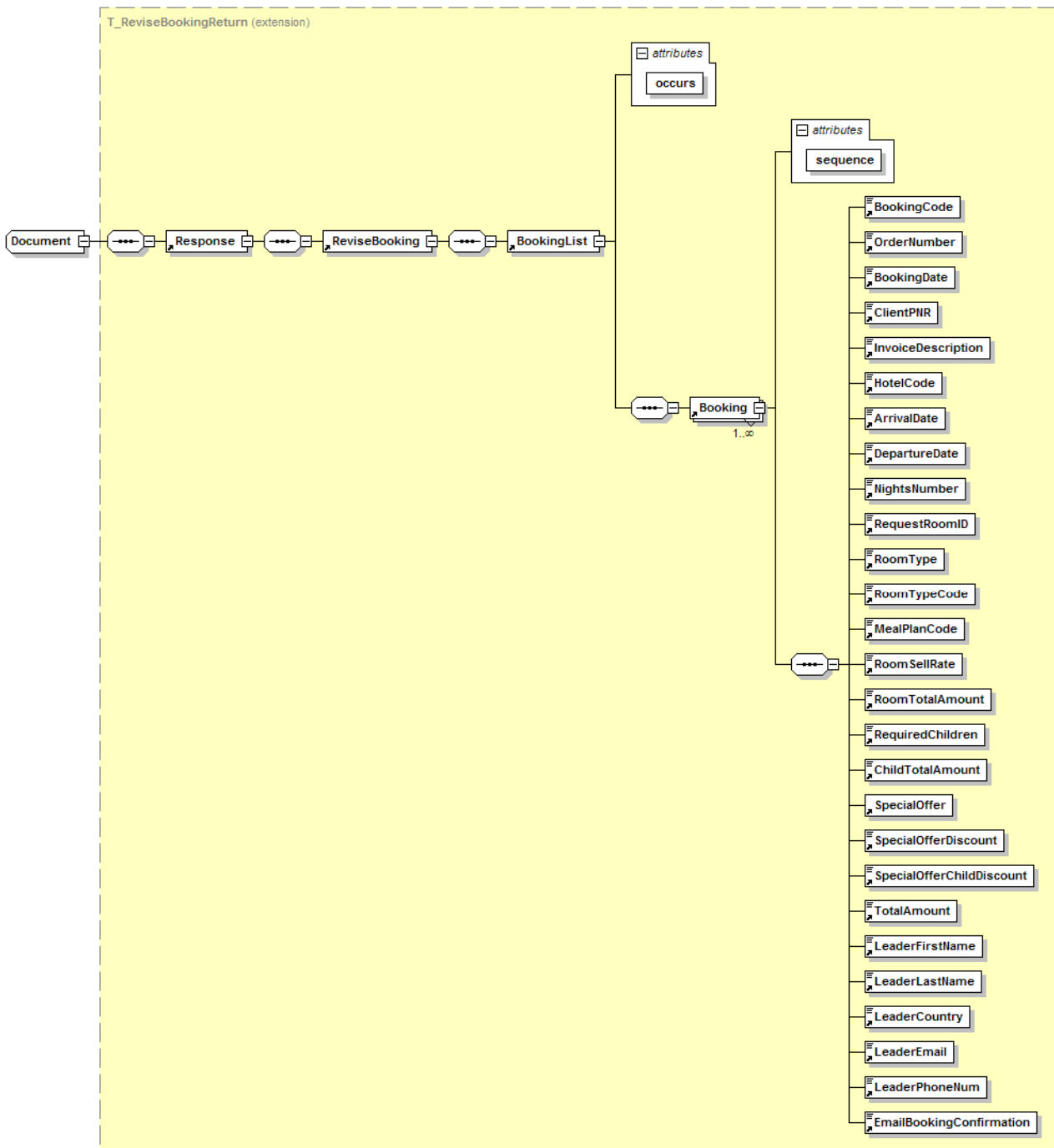

Generated by XMLSpy

www.altova.com

//Response/ReviseBooking/**BookingList**

This element contains the details list of all bookings requested by the message `ReviseBooking_request`  
Attributes

- `occurs=` Number of repeated tag "Booking" contained in the "BookingList"

// Response/ReviseBooking/BookingList /**Booking**

Attributes:

- `sequence=` Progressive of "Booking" on the inside of "BookingList"

//Response/ReviseBooking/BookingList/Booking/**Booking Code**

Identification code released by Amandatour

//Response/ReviseBooking/BookingList /Booking/**BookingOrderNumber**

Order number released by Amandatour. Such order number will be included as reference in the invoice to be sent by Amandatour to the Web Service Client/user

//Response/ReviseBooking/BookingList /Booking/**Booking Date**

Date when has been executed and confirmed the booking by Amandatour

//Response/ReviseBooking/BookingList /Booking/**ClientPNR**

File reference number of Client's system

//Response/ReviseBooking/BookingList /Booking/**InvoiceDescription**

Description of the order that will be mentioned in the invoice issued by Amandatour

// Response/ReviseBooking/BookingList /Booking /**HotelCode**

Hotel identification code returned by the message AvailabilityList\_Response

//Response/ReviseBooking/BookingList /Booking/**ArrivalDate**

Date of stay's start

//Response/ReviseBooking/BookingList /Booking/**DepartureDate**

Date of stay's end

//Response/ReviseBooking/BookingList /Booking/**RequestRoomID**

Identification number of rooms request inserted in the message AvailabilityList\_Request and returned by the message AvailabilityList\_Response

//Response/ReviseBooking/BookingList /Booking/**RoomType**

Type of room returned by the message AvailabilityList\_Response

//Response/ReviseBooking/BookingList /Booking/**RoomTypeCode**

Code of the room type returned by the message AvailabilityList\_Response

//Response/ReviseBooking/BookingList /Booking/**MealPlaneCode**

Code of the meals plan applied to the room returned by the message AvailabilityList\_Response

//Response/ReviseBooking/BookingList /Booking/**RoomSellRate**

Room selling selling price applied to the first day of stay returned by the message AvailabilityList\_Response

//Response/ReviseBooking/BookingList /Booking/**RoomTotalAmount**

Total room price for the whole requested stay returned by the message AvailabilityList\_Response

//Response/ReviseBooking/BookingList /Booking/**RequiredChidren**

Number of requested children in the message AvailabilityList\_Request. If no children have been requested, insert the element with 0 value.

//Response/ReviseBooking/BookingList /Booking/**ChildTotalAmount**

Children total selling price for the whole requested stay returned by the message AvailabilityList\_Response. If no children have been requested, insert the element with 0 value.

//Response/ReviseBooking/BookingList /Booking/**SpecialOffer**

Description of the special offer returned by the message AvailabilityList\_Response. If no special offer has been applied, insert the element with "null" value

// Response/ReviseBooking/BookingList /Booking/**SpecialOfferDiscount**

Total amount to be discounted on the rooms total selling price for the whole requested stay returned by the message AvailabilityList\_Response. If any amount of discount returned, insert the element with 0 value.

//Response/ReviseBooking/BookingList /Booking/**SpecialOfferChildDiscount**

Total amount to be discounted on the rooms total selling price for the whole children requested stay returned by the message AvailabilityList\_Response. If any amount of discount returned, insert the element with 0 value.

//Response/ReviseBooking/BookingList /Booking/**TotalAmountAccommodation**

Total amount of reserved rooms returned by the message AvailabilityList\_Response

//Response/ReviseBooking/BookingList /Booking/**LeaderFirstName**

Name of the reference pax

//Response/ReviseBooking/BookingList /Booking/**LeaderLastName**

Surname of the reference pax

//Response/ReviseBooking/BookingList /Booking/**CountryName**

Reference pax country of origin

//Response/ReviseBooking/BookingList /Booking//**LeaderEmail**

Reference pax e-mail

//Response/ReviseBooking/BookingList /Booking/**LeaderPhoneNum**

Reference pax telephone number

//Response/ReviseBooking/BookingList /Booking/**EmailBookingConfirmation**

E-mail address of the Web Service Client/user for the pro-forma invoice sending (Booking Confirmation)

#### Example (ReviseBooking\_Response.xml)

```
<soapenv:Envelope xmlns:soapenv="http://schemas.xmlsoap.org/soap/envelope/"
xmlns:xsd="http://www.w3.org/2001/XMLSchema" xmlns:xsi="http://www.w3.org/2001/XMLSchema-instance">
  <soapenv:Body>
    <ns1:ReviseBookingResponse soapenv:encodingStyle="http://schemas.xmlsoap.org/soap/encoding/"
xmlns:ns1="ama">
      <ReviseBookingReturn xsi:type="ns2:Document" xmlns:ns2="http://xml.apache.org/xml-
soap">
        <Response>
          <ReviseBooking>
            <BookingList occurs="2">
              <Booking sequence="1">
                <BookingCode>99999456</BookingCode>
                <OrderNumber>201452008</OrderNumber>
                <BookingDate>15-07-2008</BookingDate>
                <ClientPNR>P002</ClientPNR>
                <InvoiceDescription>Trip to Rome for 2
                <HotelCode>ROM35</HotelCode>
                <ArrivalDate>10-01-2008</ArrivalDate>
                <DepartureDate>10-03-2008</DepartureDate>
                <NightsNumber>2</NightsNumber>
                <RequestRoomID>1</RequestRoomID>
                <RoomType>DOUBLE CLASSIC</RoomType>
                <RoomTypeCode>DB CLA</RoomTypeCode>
                <MealPlanCode>BB</MealPlanCode>
                <RoomSellRate>398</RoomSellRate>
                <RoomTotalAmount>796</RoomTotalAmount>
                pax</InvoiceDescription>
              </Booking>
            </BookingList>
          </ReviseBooking>
        </Response>
      </ReviseBookingReturn>
    </ns1:ReviseBookingResponse>
  </soapenv:Body>
</soapenv:Envelope>
```

```

<RequiredChildren>0</RequiredChildren>
<ChildTotalAmount>0</ChildTotalAmount>
<SpecialOffer/>
<SpecialOfferDiscount>0</SpecialOfferDiscount>

<SpecialOfferChildDiscount>0</SpecialOfferChildDiscount>
<TotalAmount>796</TotalAmount>
<LeaderFirstName>Joe</LeaderFirstName>
<LeaderLastName>Citizen</LeaderLastName>
<LeaderCountry>England</LeaderCountry>
<LeaderEmail>x@xx.uk</LeaderEmail>

<LeaderPhoneNum>111345444666</LeaderPhoneNum>

<EmailBookingConfirmation>booking@client.com</EmailBookingConfirmation>
  </Booking>
  <Booking sequence="2">
    <BookingCode>99999457</BookingCode>
    <OrderNumber>201462008</OrderNumber>
    <BookingDate>16-07-2008</BookingDate>
    <ClientPNR>P002</ClientPNR>
    <InvoiceDescription>Trip to Rome for 2

pax</InvoiceDescription>

    <HotelCode>ROM35</HotelCode>
    <ArrivalDate>10-01-2008</ArrivalDate>
    <DepartureDate>10-03-2008</DepartureDate>
    <NightsNumber>2</NightsNumber>
    <RequestRoomID>1</RequestRoomID>
    <RoomType>DOUBLE DELUXE</RoomType>
    <RoomTypeCode>DB

DELUXE</RoomTypeCode>

    <MealPlanCode>BB</MealPlanCode>
    <RoomSellRate>398</RoomSellRate>
    <RoomTotalAmount>796</RoomTotalAmount>
    <RequiredChildren>0</RequiredChildren>
    <ChildTotalAmount>0</ChildTotalAmount>
    <SpecialOffer/>
    <SpecialOfferDiscount>0</SpecialOfferDiscount>

  </BookingList>
  </ReviseBooking>
  </Response>
</ReviseBookingReturn>
</ns1:ReviseBookingResponse>
</soapenv:Body>
</soapenv:Envelope>

    <SpecialOfferChildDiscount>0</SpecialOfferChildDiscount>
    <TotalAmount>796</TotalAmount>
    <LeaderFirstName>Mary</LeaderFirstName>
    <LeaderLastName>Holmert</LeaderLastName>
    <LeaderCountry>England</LeaderCountry>
    <LeaderEmail>x@xx.uk</LeaderEmail>

    <LeaderPhoneNum>111345444666</LeaderPhoneNum>

    <EmailBookingConfirmation>booking@client.com</EmailBookingConfirmation>
  </Booking>
  </BookingList>
  </ReviseBooking>
  </Response>
</ReviseBookingReturn>
</ns1:ReviseBookingResponse>
</soapenv:Body>
</soapenv:Envelope>

```

## 4.5 ChangeBooking\_Request

This message enables the modification of some fields representative of a reservation. The modifiable fields are :

- ClientPNR
- BookingDescription
- LeaderFirstName
- LeaderLastName
- LeaderCountry
- LeaderEmail
- LeaderPhonNumber
- EmailBookingConfirmation

It is not possible to modify all fields where such modification generates the selling price change or the availability's alteration. In this case a cancellation request and a new message MakeBooking\_Request must be sent

*Message structure:*

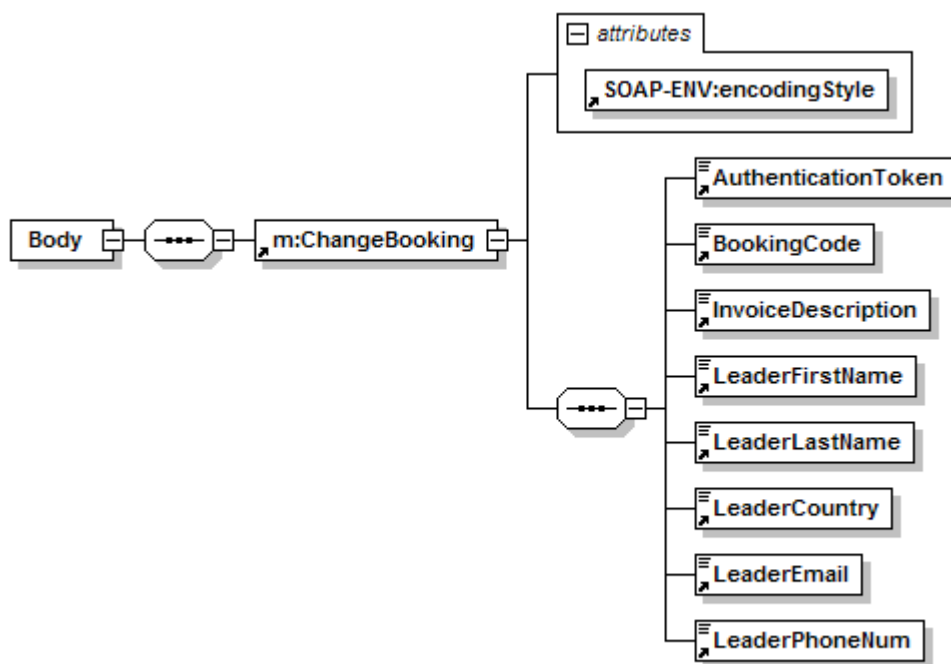

Generated by XMLSpy

www.altova.com

//ChangeBooking/**AuthenticationToken**

In this element must be inserted the authentication token returned by the "Login\_Response" If a wrong token has been inserted, the system responds with following error :

```
<Error>
  <ErrorCode>E000101</ErrorCode>
  <ErrorDescription>Login Failed</ErrorDescription>
</Error>
```

**//ChangeBooking/BookingCode**

Booking identification code returned by the message "MakeBooking\_Response". By entering such criterion , only the data of the booking corresponding to the inserted request code will be returned

**//ChangeBooking/InvoiceDescription**

Description of the order that will be mentioned in the invoice issued by Amandatour.

**//ChangeBooking/LeaderFirstName**

Name of the reference pax.

**//ChangeBooking/LeaderLastName**

Surname of the reference pax.

**//ChangeBooking/CountryName**

Reference pax country of origin.

**//ChangeBooking//LeaderEmail**

Reference pax e-mail.

**//ChangeBooking/LeaderPhoneNum**

Reference pax telephone number

Example (ChangeBooking\_Request.xml)

```
<SOAP-ENV:Envelope xmlns:SOAP-ENV="http://schemas.xmlsoap.org/soap/envelope/" xmlns:SOAP-ENC="http://schemas.xmlsoap.org/soap/encoding/" xmlns:xsi="http://www.w3.org/2001/XMLSchema-instance" xmlns:xsd="http://www.w3.org/2001/XMLSchema">
  <SOAP-ENV:Body>
    <m:ChangeBooking xmlns:m="ama" SOAP-ENV:encodingStyle="http://schemas.xmlsoap.org/soap/encoding/">
      <AuthenticationToken xsi:type="xsd:string"> xxxxxxxxxxxxxx </AuthenticationToken>
      <BookingCode xsi:type="xsd:string">99999456</BookingCode>
      <InvoiceDescription xsi:type="xsd:string">Trip to rome for 2
pax</InvoiceDescription>
      <LeaderFirstName xsi:type="xsd:string">Laura</LeaderFirstName>
      <LeaderLastName xsi:type="xsd:string">Citizen</LeaderLastName>
      <LeaderCountry xsi:type="xsd:string">England</LeaderCountry>
      <LeaderEmail xsi:type="xsd:string">x@xx.uk</LeaderEmail>
      <LeaderPhoneNum xsi:type="xsd:string">2233557765</LeaderPhoneNum>
    </m:ChangeBooking>
  </SOAP-ENV:Body>
</SOAP-ENV:Envelope>
```

## 4.6 ChangeBooking\_Response

This message contains the outcome of the request of the reservation's representative data modification. Should the Web Service refuse the modification, the message will contain following error :

```
<Error>
  <ErrorCode>E000202</ErrorCode>
  <ErrorDescription Changes not accepted </ErrorDescription>
</Error>
```

Message structure:

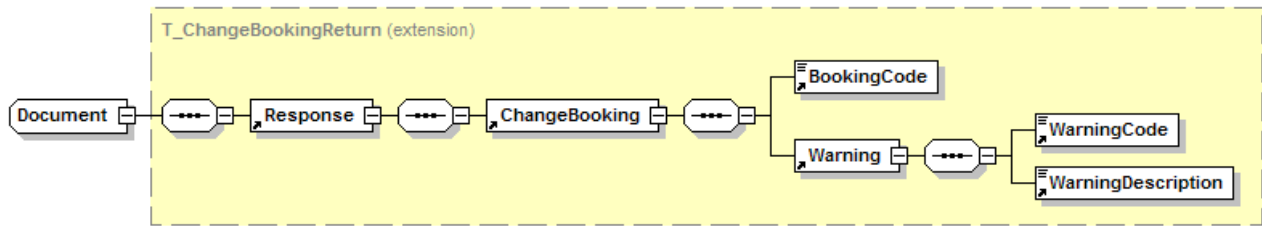

Generated by XMLSpy

www.altova.com

Example (ChangeBooking\_Response.xml)

```

<Response>
  <ChangeBooking >
    <BookingCode>99999456</ BookingCode >
    <Warning>
      <WarningCode>W0000460</ WarningCode >
      <WarningDescription>Changes accepted</ WarningDescription >
    </ChangeBooking >
  </Response>

```

## 4.7 CancelBooking\_Request

This message allows the request of cancellation of a confirmed reservation. After entering the Booking code , the Web Service will mark it out if the operation's date is lower or equal to the date within which the cancellation without penalty is possible. If penalty must be applied, the reservation will be anyway cancelled and an asynchronous response will be given by Amandatour with the calculation of the penalty's amount.

Message's structure:

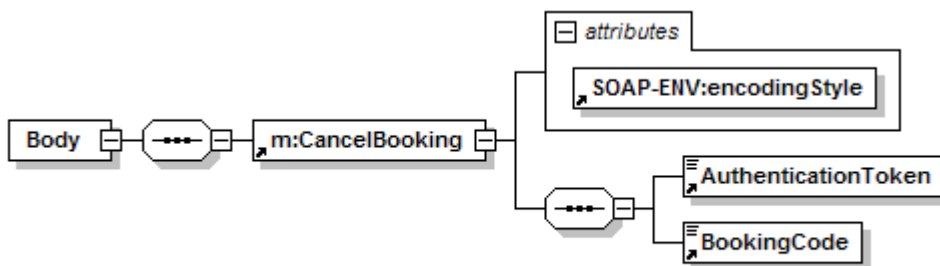

Generated by XMLSpy

www.altova.com

//CancelBooking/**AuthenticationToken**

In this element must be inserted the authentication token returned by the "Login\_Response". If a wrong token has been inserted, the system responds with following error :

```

<Error>
  <ErrorCode>E000101</ErrorCode>
  <ErrorDescription>Login Failed</ErrorDescription>
</Error>

```



//CancelBooking/**BookingCode**

Booking identification code returned by the message "MakeBooking\_Response".

Example (CancelBooking\_Request.xml)

```
<SOAP-ENV:Envelope xmlns:SOAP-ENV="http://schemas.xmlsoap.org/soap/envelope/" xmlns:SOAP-ENC="http://schemas.xmlsoap.org/soap/encoding/" xmlns:xsi="http://www.w3.org/2001/XMLSchema-instance" xmlns:xsd="http://www.w3.org/2001/XMLSchema">
  <SOAP-ENV:Body>
    <m:CancelBooking xmlns:m="ama" SOAP-ENV:encodingStyle="http://schemas.xmlsoap.org/soap/encoding/">
      <AuthenticationToken xsi:type="xsd:string"> xxxxxxxxxxxxxxxx </AuthenticationToken>
      <BookingCode xsi:type="xsd:string">99999456</BookingCode>
    </m:CancelBooking>
  </SOAP-ENV:Body>
</SOAP-ENV:Envelope>
```

## 4.8 CancelBooking\_Response

This message contains the cancellation request out come. Should the Web Service refuse the modification , the response will be as follows :

```
<Error>
  <ErrorCode>E000205</ErrorCode>
  <ErrorDescription Delete not accepted </ErrorDescription>
</Error>
```

Message structure:

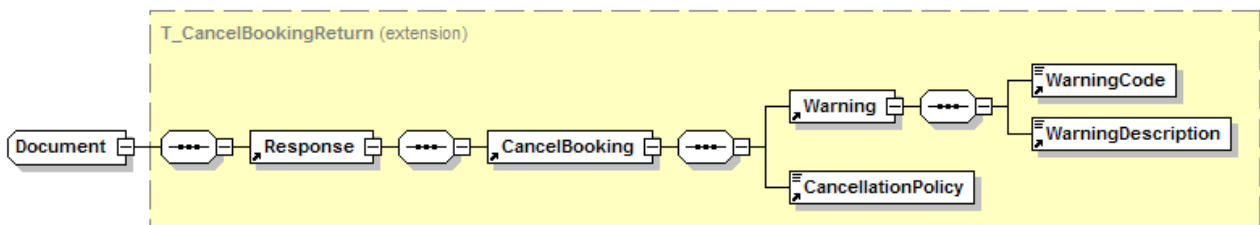

Generated by XMLSpy

www.altova.com

//CancelBooking/**AuthenticationToken**

In this element must be inserted the authentication token returned by the Login\_Response-. If a wrong token has been inserted, the system responds with following error :

```
<Error>
  <ErrorCode>E000101</ErrorCode>
  <ErrorDescription>Login Failed</ErrorDescription>
</Error>
```

//CancelBooking/**ReservationDelete**

It contains the cancellation result

//CancelBooking/**CancellationPolicy**

If no penalties are applied, the element shall contain the message "No penalty", otherwise the cancellation penalty will be showed. Subsequently Amandatour will respond with the calculation of the penalty's amount.

### Example (*CancelBooking Response.xml*)

```
<soapenv:Envelope xmlns:soapenv="http://schemas.xmlsoap.org/soap/envelope/"
xmlns:xsd="http://www.w3.org/2001/XMLSchema" xmlns:xsi="http://www.w3.org/2001/XMLSchema-
instance">
  <soapenv:Body>
    <ns1:CancelBookingResponse
soapenv:encodingStyle="http://schemas.xmlsoap.org/soap/encoding/" xmlns:ns1="ama">
      <CancelBookingReturn xsi:type="ns2:Document"
xmlns:ns2="http://xml.apache.org/xml-soap">
        <Response>
          <CancelBooking>
            <Warning>
              <WarningCode>W0000480</WarningCode>
              <WarningDescription>Delete
confirmed</WarningDescription>
            </Warning>
            <CancellationPolicy>No penalty</CancellationPolicy>
          </CancelBooking>
        </Response>
      </CancelBookingReturn>
    </ns1:CancelBookingResponse>
  </soapenv:Body>
</soapenv:Envelope>
```

## 5 HotelsList

This message allows to request the Web Service the list of all featured and active hotels. The list provides with the main data of each hotel (Code, Name, Address, Post code, Telephone, City, Region, Province).

### 5.1 HotelsList\_Request

This message allows to request the hotel list of a certain City and/or of a certain Class and/or of a certain Name and/or of a certain Code. If no hotel has been found the return message is :

Message structure :

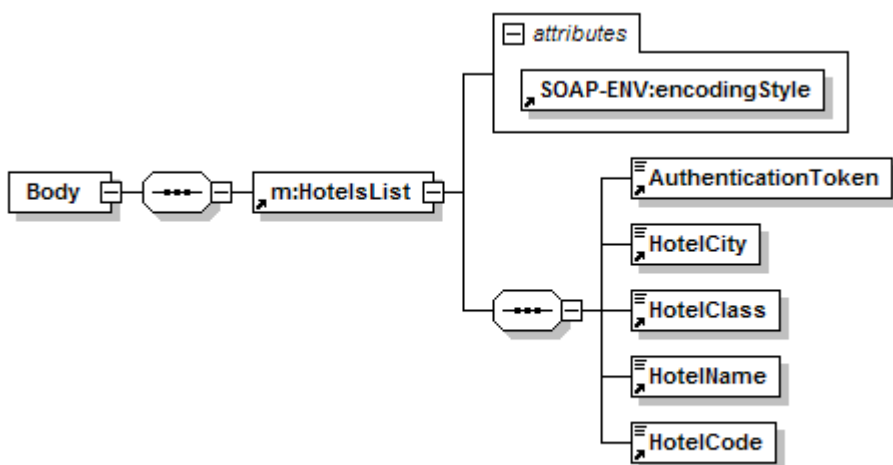

### //HotelsList/**AuthenticationToken**

In this element must be inserted the authentication token returned by the "Login\_Response".  
If a wrong token has been inserted, the system responds with following error :

```
<Error>
  <ErrorCode>E000101</ErrorCode>
  <ErrorDescription>Login Failed</ErrorDescription>
</Error>
```

### //HotelsList/**City**

Name of the city where the hotels are situated.

### //HotelsList/**Class**

Hotel Class.

### //HotelsList/**HotelName**

Hotel Name.

### //HotelsList/**HotelCode**

Identification hotel code in the Amandatour Database.

### Example (*HotelList Request.xml*)

```
<SOAP-ENV:Envelope xmlns:SOAP-ENV="http://schemas.xmlsoap.org/soap/envelope/" xmlns:SOAP-
ENC="http://schemas.xmlsoap.org/soap/encoding/" xmlns:xsi="http://www.w3.org/2001/XMLSchema-
instance" xmlns:xsd="http://www.w3.org/2001/XMLSchema">
  <SOAP-ENV:Body>
    <m:HotelList xmlns:m="ama" SOAP-
ENV:encodingStyle="http://schemas.xmlsoap.org/soap/encoding/">
      <AuthenticationToken xsi:type="xsd:string"> xxxxxxxxxxxxxx </AuthenticationToken>
      <HotelCity xsi:type="xsd:string">Roma</HotelCity>
      <HotelClass xsi:type="xsd:string">*</HotelClass>
      <HotelName xsi:type="xsd:string"></HotelName>
      <HotelCode xsi:type="xsd:string"></HotelCode>
    </m:HotelList>
  </SOAP-ENV:Body>
</SOAP-ENV:Envelope>
```

## 5.2 *HotelList\_Response*

The message returns a list with all information on the hotel's details corresponding to the inserted search criteria.

If no hotel has been found the message will return with the following error :

```
<Error>
  <ErrorCode> E0000520</ErrorCode>
  <ErrorDescription> Hotels not found for the following search criteria
entered:[Roma][***][astoria][sss]</ErrorDescription>
</Error>
```

Message structure :

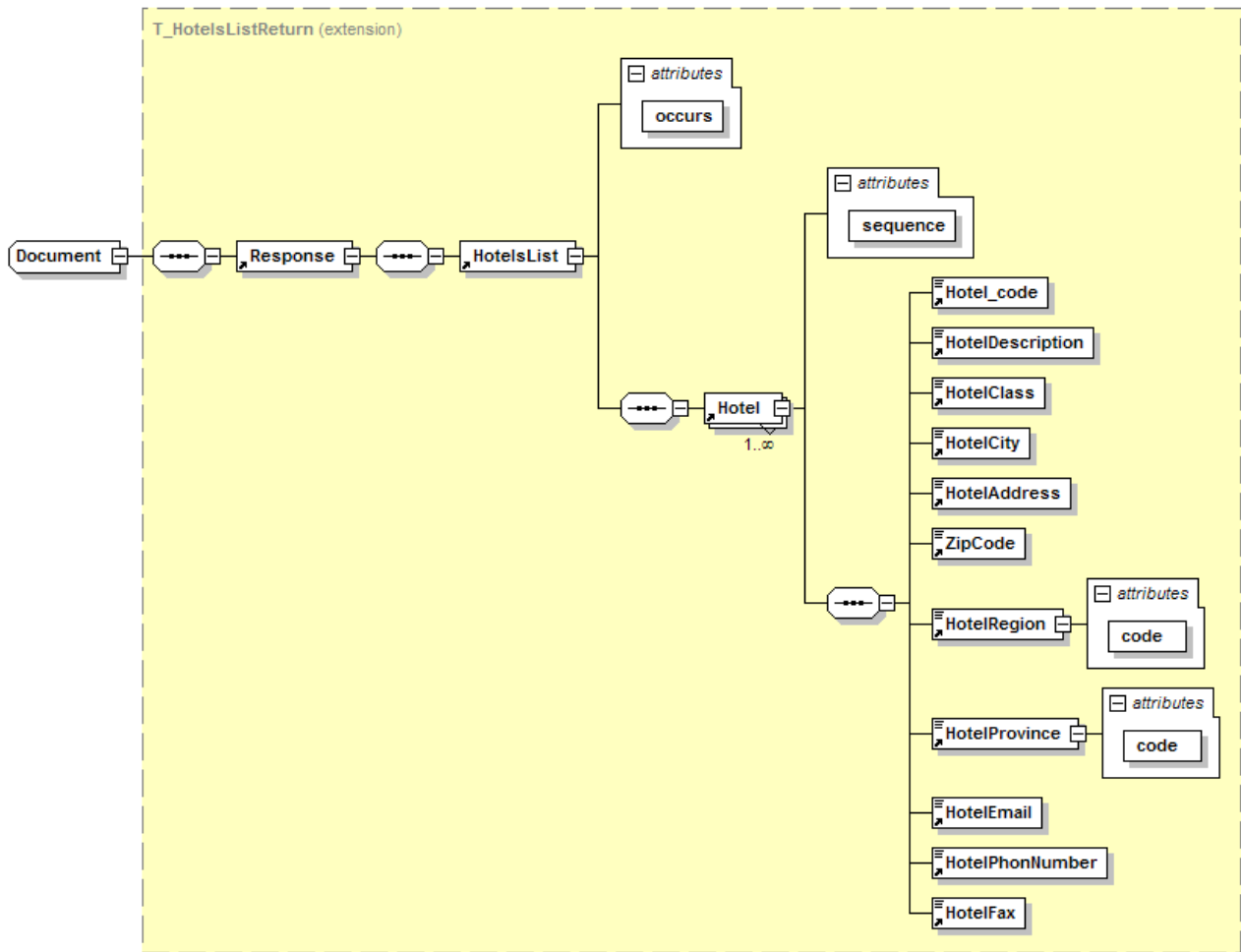

Generated by XMLSpy

www.altova.com

//Response/**HotelsList**

Attributes:

- Number of hotel elements repeated in the list.

//Response/HotelsList/**Hotel**

//Response/HotelsList/Hotel/**HotelCode**

Hotel identification code

//Response/HotelsList/Hotel/**HotelName**

Trade name

//Response/HotelsList/Hotel/**Hotelclass**

Categoria di appartenenza dell'hotel  
Hotel's class

//Response/HotelsList/Hotel/**HotelCity**

City or place where the hotel is situated

//Response/HotelsList/Hotel/ **HotelAddress**

Hotel address

//Response/HotelsList/Hotel/**ZipCode**

Post code

//Response/HotelsList/Hotel/**HotelRegione**  
Region where the hotel is situated

//Response/HotelsList/Hotel/**HotelProvince**  
Province

//Response/HotelsList/Hotel/**HotelEmail**  
Hotel's e-mail address

//Response/HotelsList/Hotel/**HotelPhonNumber**  
Telephone number

//Response/HotelsList/Hotel/**HotelFax**>  
Fax number

### Example (HotelsList Response.xml)

```
<soapenv:Envelope xmlns:soapenv="http://schemas.xmlsoap.org/soap/envelope/"
xmlns:xsd="http://www.w3.org/2001/XMLSchema" xmlns:xsi="http://www.w3.org/2001/XMLSchema-instance">
  <soapenv:Body>
    <ns1:HotelsListResponse soapenv:encodingStyle="http://schemas.xmlsoap.org/soap/encoding/"
xmlns:ns1="ama">
      <HotelsListReturn xsi:type="ns2:Document" xmlns:ns2="http://xml.apache.org/xml-soap">
        <Response>
          <HotelsList occurs="4">
            <Hotel sequence="1">
              <Hotel_code>ROMO1</Hotel_code>
              <HotelDescription>BUONARROTI HOME
HOTEL</HotelDescription>
              <HotelClass>**</HotelClass>
              <HotelCity>ROMA</HotelCity>
              <HotelAddress>Via Carlo Alberto, 43</HotelAddress>
              <ZipCode>00185</ZipCode>
              <HotelRegion code="LA">LAZIO</HotelRegion>
              <HotelProvince code="RM">ROMA</HotelProvince>
              <HotelEmail> info@buonarrotihome.com</HotelEmail>
              <HotelPhonNumber>06 44704334</HotelPhonNumber>
              <HotelFax>06 44360687</HotelFax>
            </Hotel>
            <Hotel sequence="2">
              <Hotel_code>ROM64</Hotel_code>
              <HotelDescription>GIOTTO FLAVIA
HOTEL</HotelDescription>
              <HotelClass>**</HotelClass>
              <HotelCity>ROMA</HotelCity>
              <HotelAddress>Via Flavia, 84</HotelAddress>
              <ZipCode>00187</ZipCode>
              <HotelRegion code="LA">LAZIO</HotelRegion>
              <HotelProvince code="RM">ROMA</HotelProvince>
              <HotelEmail/>
              <HotelPhonNumber>06 42011651</HotelPhonNumber>
              <HotelFax>06 42000904</HotelFax>
            </Hotel>
            <Hotel sequence="3">
              <Hotel_code>ROM89</Hotel_code>
              <HotelDescription>LUZZATTI HOTEL</HotelDescription>
              <HotelClass>**</HotelClass>
              <HotelCity>ROMA</HotelCity>
              <HotelAddress>Via Luzzatti, 3</HotelAddress>
              <ZipCode>00185</ZipCode>
              <HotelRegion code="LA">LAZIO</HotelRegion>
              <HotelProvince code="RM">ROMA</HotelProvince>
              <HotelEmail>info@hotelluzzatti.it</HotelEmail>
              <HotelPhonNumber>06 7004978</HotelPhonNumber>
              <HotelFax>06 7004376</HotelFax>
            </Hotel>
          </HotelsList>
        </Response>
      </HotelsListResponse>
    </ns1:HotelsListResponse>
  </soapenv:Body>
</soapenv:Envelope>
```

```

HOTEL</HotelDescription>
49/51</HotelAddress>
HOTEL</Hotel>
<Hotel sequence="4">
  <Hotel_code>ROMI3</Hotel_code>
  <HotelDescription>TAORMINA
  <HotelClass>**</HotelClass>
  <HotelCity>ROMA</HotelCity>
  <HotelAddress>Via Principe Eugenio
  <ZipCode>00185</ZipCode>
  <HotelRegion code="LA">LAZIO</HotelRegion>
  <HotelProvince code="RM">ROMA</HotelProvince>
  <HotelEmail>hoteltaormina@hoteltaormina.net</HotelEmail>
  <HotelPhonNumber>064464754</HotelPhonNumber>
  <HotelFax>064464703</HotelFax>
</Hotel>
</HotelsList>
</Response>
</HotelsListReturn>
</ns1:HotelsListResponse>
</soapenv:Body>
</soapenv:Envelope>

```

## 6 HotelDetails

This message allows to request the Web Service all information on hotel's description ( Description in different languages, Location, Facilities, Pictures, Terrestrial coordinates )

### 6.1 HotelDetail\_Request

Message structure :

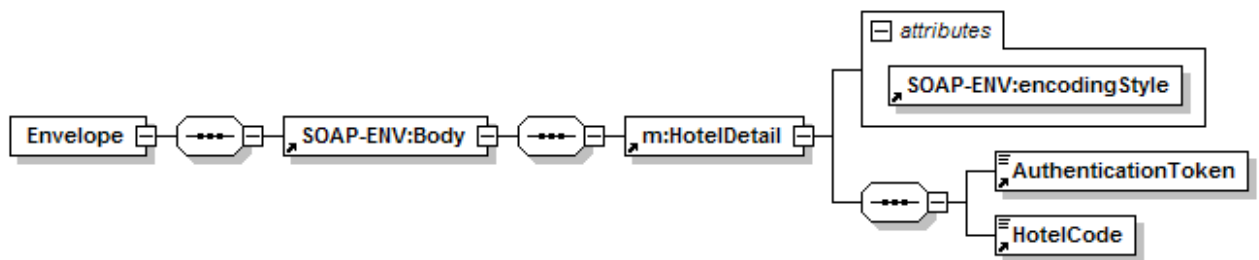

Generated by XMLSpy

www.altova.com

//HotelDetail/**AuthenticationToken**

In this element must be inserted the authentication token returned by the "Login\_Response". If a wrong token has been inserted, the system responds with following error :

```

<Error>
  <ErrorCode>E000101</ErrorCode>
  <ErrorDescription>Login Failed</ErrorDescription>
</Error>

```

//HotelDetail/**HotelCode**

Identification hotel code in the Amandatour Database

### Example (HotelDetail Request.xml)

```
<SOAP-ENV:Envelope xmlns:SOAP-ENV="http://schemas.xmlsoap.org/soap/envelope/" xmlns:SOAP-ENC="http://schemas.xmlsoap.org/soap/encoding/" xmlns:xsi="http://www.w3.org/2001/XMLSchema-instance" xmlns:xsd="http://www.w3.org/2001/XMLSchema">
  <SOAP-ENV:Body>
    <m:HotelDetail xmlns:m="ama" SOAP-ENV:encodingStyle="http://schemas.xmlsoap.org/soap/encoding/">
      <AuthenticationToken xsi:type="xsd:string"> xxxxxxxxxxxxxx </AuthenticationToken>
      <HotelCode xsi:type="xsd:string">Rom35</HotelCode>
    </m:HotelDetail>
  </SOAP-ENV:Body>
</SOAP-ENV:Envelope>
```

## **6.2 HotelDetail\_Response**

The message returns a list with all information on the hotel's details corresponding to the inserted search criteria.

If no hotel has been found the message will return with the following error :

```
<ErrorCode>E000110</ErrorCode>
  <ErrorDescription> Hotels not found for the search criteria entered</ErrorDescription>
</Error>
```

Message structure :

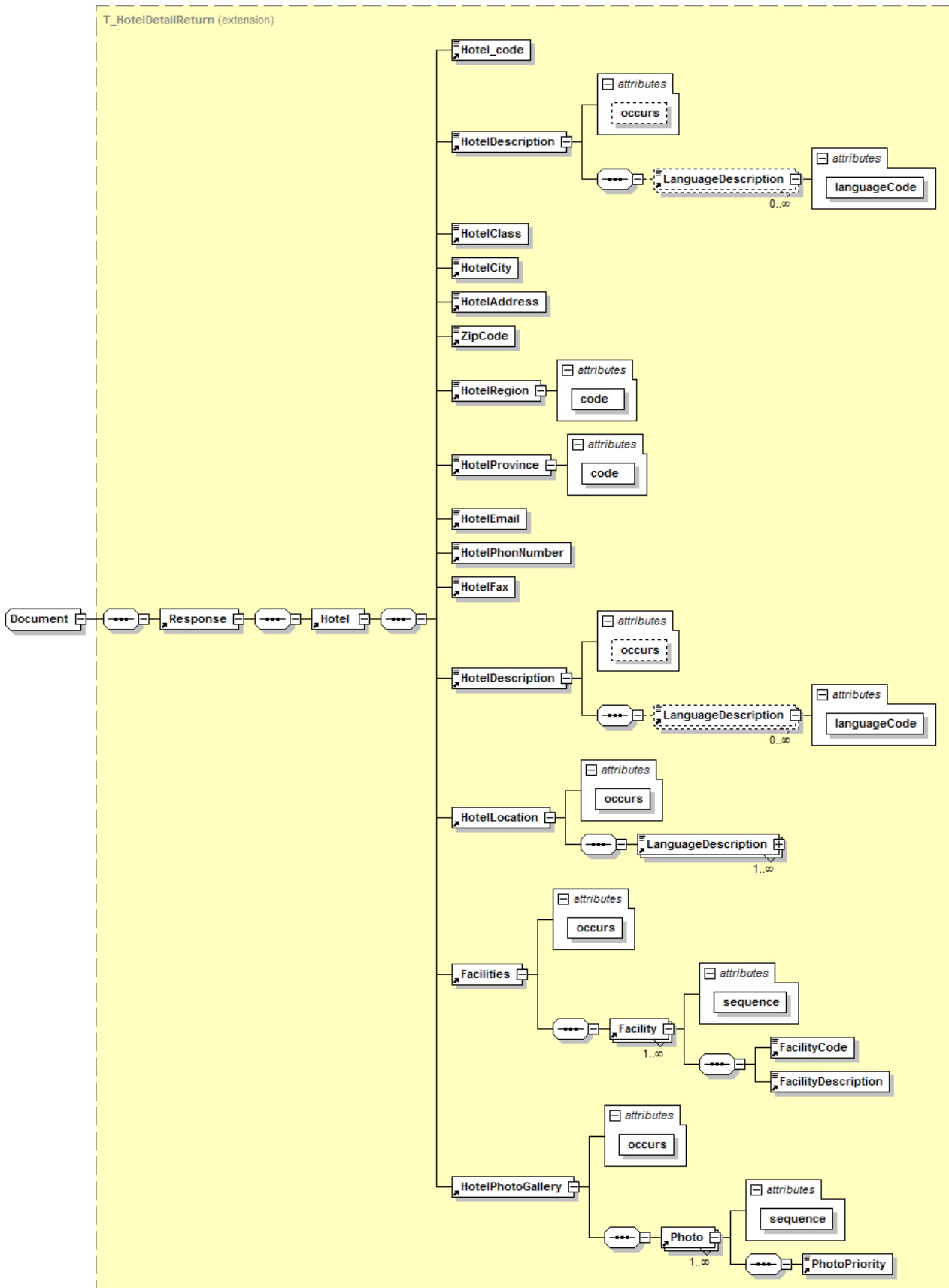



//Response/HotelDetail/**Hotel**

It contains the detailed hotel information

//Response/HotelDetail /Hotel/**HotelCode**

Hotel Identification code

//Response/HotelDetail/Hotel/**HotelName**

Trade name

//Response/HotelDetail/Hotel/**Hotelclass**

Hotel's class

//Response/HotelDetail/Hotel/**Hotel City**

City or place where the hotel is situated

//Response/HotelDetail/Hotel/**HotelAddress**

Hotel address

//Response/HotelDetail/Hotel/**ZipCode**

Post code

//Response/HotelDetail/Hotel/**HotelRegione**

Region where the hotel is situated

//Response/HotelDetail/Hotel/HotelProvince

Province

//Response HotelDetail/Hotel/**HotelEmail**

Indirizzo Email dell'hotel

Hotel's e-mail address

//Response/HotelDetail/Hotel/**HotelPhonNumber**

Telephone number

//Response/HotelDetail/Hotel/**HotelFax**

Fax number

//Response/HotelDetail/Hotel/**HoteDescription**

This element contains repeatedly the tag <LanguageDescription>

//Response/HotelDetail/Hotel/HoteDescription/**LanguageDescription**

It contains the hotel's description in different languages

Attributes:

- Language code

//Response/HotelDetail/Hotel/HoteLocation/LanguageLocation

It contains the description of the hotel's location in different languages

Attributes:

- Language code

//Response/HotelDetail/Hotel/**Facilities**

It contains repeatedly the tag <Facility>

Attributes:

- occurs=" number of repetitions of the hotel's facilities

//Response/HotelDetail/Hotel/Facility/**FacilityCode**

Code of the facility



&#x412;&#x438;&#x430; &#x412;&#x435;&#x43D;&#x435;&#x442;&#x43E;, &#x432; &#x434;&#x432;&#x443;&#x445;  
&#x448;&#x430;&#x433;&#x430;&#x445; &#x43E;&#x442; &#x412;&#x438;&#x430;  
&#x411; &#x430;&#x440;&#x431; &#x435;&#x440;&#x438;&#x43D;&#x438;,  
&#x43F;&#x43B;&#x43E;&#x449;&#x430;&#x434;&#x438; &#x418;&#x441; &#x43F;&#x430;&#x43D;&#x438;&#x438;  
&#x438; &#x43F;&#x43B;&#x43E;&#x449;&#x449;&#x430;&#x434;&#x438; &#x41D;&#x432;&#x43E;&#x43D;&#x430;.  
&#x41F;&#x435;&#x440;&#x432;&#x43E;&#x43A;&#x43B;&#x430;&#x441; &#x441; &#x43D;&#x44B;&#x439;  
&#x441; &#x435;&#x440;&#x432;&#x438;&#x441;,  
&#x43F;&#x440;&#x435;&#x441; &#x442;&#x438;&#x436;&#x43D;&#x44B;&#x435; &#x438;  
&#x438;&#x437;&#x44B;&#x441; &#x43A;&#x430;&#x43D;&#x43D;&#x44B;&#x435;  
&#x43F;&#x440;&#x435;&#x434;&#x43C;&#x435;&#x442;&#x44B; &#x43C;&#x435;&#x431; &#x435;&#x43B;&#x438;  
&#x434;&#x435;&#x43B;&#x430;&#x44E;&#x442; &#x43E;&#x442; &#x435;&#x43B;&#x44C;  
&#x438; &#x434;&#x43D;&#x438;&#x43C; &#x438; &#x437; &#x441; &#x430;&#x44B;&#x445;  
&#x438;&#x437;&#x432;&#x435;&#x441; &#x442;&#x43D;&#x44B;&#x445; &#x432; &#x420;&#x438;&#x43C;&#x435;.  
&#x41D;&#x435;&#x434;&#x430;&#x432;&#x43D;&#x43E;  
&#x43E;&#x442;&#x440;&#x435;&#x441; &#x442;&#x430;&#x432;&#x440;&#x438;&#x440;&#x43E;&#x432;&#x430;&#x43D;&#x43D;&#x44B;&#x439; &#x43E;&#x442;&#x435;&#x43B;&#x44C;  
&#x440;&#x430;&#x441; &#x43F;&#x43E;&#x43B;&#x430;&#x433;&#x430;&#x435;&#x442; 143  
&#x44D;&#x43B;&#x435;&#x433;&#x430;&#x43D;&#x442;&#x43D;&#x44B;&#x43C;&#x438;  
&#x43D;&#x430;&#x441; &#x435;&#x440;&#x430;&#x43C;&#x438; &#x441;  
&#x43E;&#x447; &#x430;&#x440;&#x43E;&#x432;&#x430;&#x442;&#x435;&#x43B;&#x44C;&#x43D;&#x44B;&#x43C;  
&#x432;&#x438;&#x434;&#x43E;&#x43C; &#x43D;&#x430; &#x441; &#x442;&#x43E;&#x43B;&#x438;&#x446;&#x443;,  
&#x43E;&#x441; &#x43D;&#x430;&#x449;&#x451; &#x43D;&#x43D;&#x44B;&#x43C;&#x438;  
&#x432;&#x441; &#x435;&#x43C;&#x438; &#x432;&#x438;&#x434;&#x430;&#x43C;&#x438;  
&#x43A;&#x43E;&#x43C;&#x444;&#x43E;&#x440;&#x442;&#x430;.  
&#x420;&#x435;&#x441; &#x442;&#x43E;&#x440;&#x430;&#x43D; &#x201E;Le Grazie del Canova&#x201D;  
&#x440;&#x430;&#x441; &#x43F;&#x440;&#x435;&#x434;&#x435;&#x43B;&#x451; &#x43D; &#x432; 4  
&#x437;&#x430;&#x43B;&#x430;&#x445;,  
&#x44D;&#x43B;&#x435;&#x433;&#x430;&#x43D;&#x442;&#x43D;&#x44B;&#x445; &#x438;  
&#x443;&#x44E;&#x442;&#x43D;&#x44B;&#x445;,  
&#x43E;&#x431; &#x43D;&#x43E;&#x432;&#x43B;&#x451; &#x43D;&#x43D;&#x44B;&#x445; &#x438;  
&#x43E;&#x431; &#x441; &#x442;&#x430;&#x432;&#x43B;&#x435;&#x43D;&#x43D;&#x44B;&#x445; &#x432;  
&#x441; &#x43E;&#x43E;&#x442;&#x432;&#x435;&#x442;&#x441; &#x442; &#x432;&#x438; &#x441; &#x43E;  
&#x441; &#x442;&#x438;&#x43B;&#x435;&#x43C; &#x43E;&#x442;&#x435;&#x43B;&#x44F;.

</LanguageDescription>  
<LanguageDescription languageCode="SPA"> El Hotel Regina Baglioni est&#xE1; situado en la Via Veneto, en un elegante edificio art nouveau de principios del siglo XX, a un breve paseo de la Via Barberini, la escalinata de la Plaza Espa&#xF1;a y la Piazza Navona. El impecable servicio y el mobiliario sofisticado y lujoso lo convierten en uno de los hoteles m&#xE1;s famosos de Roma. Recientemente renovado, el hotel dispone de 143 habitaciones elegantes, dotadas de todas las comodidades y con una encantadora vista de toda la capital. El elegante y acogedor restaurante &#x2018;Le Grazie del Canova&#x2019; posee cuatro salones, renovados y amueblados en combinaci&#xF3;n con el estilo de la mansi&#xF3;n. </LanguageDescription>

</HotelDescription>

<HotelLocation occurs="6">

<LanguageDescription languageCode="DCH">Das

Regian Baglioni Hotel befindet sich in der Via Vittorio Veneto, nur einige Gehminuten von den wichtigsten Denkm&#xE4;lern und Sehensw&#xFC;rdigkeiten entfernt. N&#xE4;chster Flughafen: Flughafen Ciampino, 15 km. Andere Ziele: Flughafen Leonardo da Vinci, 25 km. Bahnhof Rom Termini, 2 km.</LanguageDescription>

<LanguageDescription languageCode="ENG">The

Regina Baglioni hotel is located on Via Vittorio Veneto, a short walk from the principal monuments and artistic places of interest. Nearest airport: Ciampino Airport, 15 km. Other distances: Leonardo da Vinci Airport, 25 km. Rome Termini Station, 2 km.</LanguageDescription>

<LanguageDescription

languageCode="FRA">L&#x2019;h&#xF4;tel Regina Baglioni donne sur Via Vittorio Veneto, &#xE0; quelques pas des principaux monuments et des points d&#x2019;int&#xE9;r&#xEA;t artistique. A&#xE9;roport le plus proche : A&#xE9;roport de Rome Ciampino, 15 km. Autres distances : A&#xE9;roport de Rome Leonardo da Vinci, 25 km. Gare de Rome Termini, 2 km. </LanguageDescription>

<LanguageDescription languageCode="ITA">L'hotel

Regina Baglioni si trova in Via Vittorio Veneto, a due passi dai principali monumenti e luoghi di interesse artistico. Aeroporto pi&#xF9; vicino: Aeroporto di Ciampino, 15 km. Altre distanze: Aeroporto Leonardo da Vinci, 25 km. Stazione di Roma Termini, 2 km. </LanguageDescription>

<LanguageDescription

languageCode="RUS">&#x41E;&#x442;&#x435;&#x43B;&#x44C; &#x201E;Regina Baglioni&#x201D;  
&#x43D;&#x430;&#x445;&#x43E;&#x434;&#x438;&#x442;&#x441; &#x44F; &#x43D;&#x430; &#x412;&#x438;&#x430;  
&#x412;&#x438;&#x442;&#x442;&#x43E;&#x440;&#x438;&#x43E; &#x412;&#x435;&#x43D;&#x435;&#x442;&#x43E;,  
&#x432; &#x434;&#x432;&#x443;&#x445; &#x448;&#x430;&#x433;&#x430;&#x445; &#x43E;&#x442;  
&#x433;&#x43B;&#x430;&#x432;&#x43D;&#x44B;&#x445;  
&#x43F;&#x430;&#x43C;&#x44F;&#x442;&#x43D;&#x438;&#x43A;&#x43E;&#x432; &#x438;  
&#x434;&#x43E;&#x441; &#x442;&#x43E;&#x43F;&#x440;&#x438;&#x43C;&#x435;&#x447; &#x430;&#x442;&#x435;&#x43B;&#x44C;&#x43D;&#x43E;&#x441; &#x442;&#x435;&#x439; &#x433;&#x43E;&#x440;&#x43E;&#x434;&#x430;.  
&#x411; &#x43B;&#x438;&#x436;&#x430;&#x439;&#x448;&#x438;&#x439;

&#x430;&#x44D;&#x440;&#x43E;&#x43F;&#x43E;&#x440;&#x442;:  
&#x430;&#x44D;&#x440;&#x43E;&#x43F;&#x43E;&#x440;&#x442;  
&#x427;&#x430;&#x43C;&#x43F;&#x438;&#x43D;&#x43E; &#x43A;&#x43C;.  
&#x420;&#x430;&#x441;&#x441;&#x442;&#x43E;&#x44F;&#x43D;&#x438;&#x435; &#x434;&#x43E;  
&#x434;&#x440;&#x443;&#x433;&#x438;&#x445; &#x43F;&#x443;&#x43D;&#x43A;&#x442;&#x43E;&#x432;:  
&#x430;&#x44D;&#x440;&#x43E;&#x43F;&#x43E;&#x440;&#x442;  
&#x41B;&#x435;&#x43E;&#x43D;&#x430;&#x440;&#x434;&#x43E; &#x434;&#x430;  
&#x412;&#x438;&#x43D;&#x447;&#x438; &#x432; 25 &#x43A;&#x43C;. &#x416;/&#x434;  
&#x441;&#x442;&#x430;&#x43D;&#x446;&#x438;&#x44F; &#x420;&#x438;&#x43C;&#x430; -  
&#x422;&#x435;&#x440;&#x43C;&#x438;&#x43D;&#x438; &#x432; 2 &#x43A;&#x43C;.</LanguageDescription>

<LanguageDescription languageCode="SPA">El Hotel  
Regian Baglioni se encuentra en Via Vittorio Veneto, a un breve paseo de los principales monumentos y lugares  
art&#xED;sticos. Aeropuerto m&#xE1;s cercano: Aeropuerto de Ciampino, 15 km. Otros destinos: Aeropuerto Leonardo  
da Vinci, 25 km. Estaci&#xF3;n de Roma Termini, 2 km.</LanguageDescription>

</HotelLocation>

<Facilities occurs="21">

<Facility sequence="1">

<FacilityCode>C01</FacilityCode>

<FacilityDescription>Telephone</FacilityDescription>

</Facility>

<Facility sequence="2">

<FacilityCode>C02</FacilityCode>

<FacilityDescription>TV

Color</FacilityDescription>

</Facility>

<Facility sequence="3">

<FacilityCode>C03</FacilityCode>

<FacilityDescription>Mini

bar</FacilityDescription>

</Facility>

<Facility sequence="4">

<FacilityCode>C04</FacilityCode>

<FacilityDescription>Hair

dryer</FacilityDescription>

</Facility>

<Facility sequence="5">

<FacilityCode>C05</FacilityCode>

<FacilityDescription>Safe Deposit

Boxes</FacilityDescription>

</Facility>

<Facility sequence="6">

<FacilityCode>C06</FacilityCode>

<FacilityDescription>Air-Conditioned

Facilities</FacilityDescription>

</Facility>

<Facility sequence="7">

<FacilityCode>C07</FacilityCode>

<FacilityDescription>Radio</FacilityDescription>

</Facility>

<Facility sequence="8">

<FacilityCode>C09</FacilityCode>

<FacilityDescription>Pay Parking

Facilities</FacilityDescription>

</Facility>

<Facility sequence="9">

<FacilityCode>C10</FacilityCode>

<FacilityDescription>Meeting

Rooms</FacilityDescription>

</Facility>

<Facility sequence="10">

<FacilityCode>C11</FacilityCode>

<FacilityDescription>Bar</FacilityDescription>

</Facility>

<Facility sequence="11">

<FacilityCode>C12</FacilityCode>

<FacilityDescription>Restaurant</FacilityDescription>

</Facility>

```

Facilities</FacilityDescription>
    <Facility sequence="12">
        <FacilityCode>C14</FacilityCode>
        <FacilityDescription>Non-Smoking
    </Facility>
    <Facility sequence="13">
        <FacilityCode>C15</FacilityCode>
        <FacilityDescription>Lift</FacilityDescription>
    </Facility>
    <Facility sequence="14">
        <FacilityCode>C16</FacilityCode>
        <FacilityDescription>Refrigerator</FacilityDescription>
    </Facility>
    <Facility sequence="15">
        <FacilityCode>C17</FacilityCode>
        <FacilityDescription>Credit Card
    </Facility>
    <Facility sequence="16">
        <FacilityCode>C19</FacilityCode>
        <FacilityDescription>Exchange
    </Facility>
    <Facility sequence="17">
        <FacilityCode>C21</FacilityCode>
        <FacilityDescription>TV Sat</FacilityDescription>
    </Facility>
    <Facility sequence="18">
        <FacilityCode>C22</FacilityCode>
        <FacilityDescription>High Speed Internet
    </Facility>
    <Facility sequence="19">
        <FacilityCode>C24</FacilityCode>
        <FacilityDescription>VHS</FacilityDescription>
    </Facility>
    <Facility sequence="20">
        <FacilityCode>C27</FacilityCode>
        <FacilityDescription>Laundry
    </Facility>
    <Facility sequence="21">
        <FacilityCode>C28</FacilityCode>
        <FacilityDescription>Transfer
    </Facility>
</Facilities>
<HotelPhotoGallery occurs="8">
    <Photo sequence="1">
        <PhotoPriority>1</PhotoPriority><![CDATA[<PhotolImage>urlimages="http://ws.amandatour.ambergris.it/images
/ROM35E.jpg"</PhotolImage>]]></Photo>
    <Photo sequence="2">
        <PhotoPriority>2</PhotoPriority><![CDATA[<PhotolImage>urlimages="http://ws.amandatour.ambergris.it/images
/ROM35C.jpg"</PhotolImage>]]></Photo>
    <Photo sequence="3">
        <PhotoPriority>3</PhotoPriority><![CDATA[<PhotolImage>urlimages="http://ws.amandatour.ambergris.it/images
/ROM35JS.jpg"</PhotolImage>]]></Photo>
    <Photo sequence="4">
        <PhotoPriority>4</PhotoPriority><![CDATA[<PhotolImage>urlimages="http://ws.amandatour.ambergris.it/images
/ROM35S.jpg"</PhotolImage>]]></Photo>
    <Photo sequence="5">
        <PhotoPriority>5</PhotoPriority><![CDATA[<PhotolImage>urlimages="http://ws.amandatour.ambergris.it/images
/ROM35I1.jpg"</PhotolImage>]]></Photo>

```

<Photo sequence="6">

<PhotoPriority>6</PhotoPriority><![CDATA[<PhotoImage>urlimages="http://ws.amandatour.ambergris.it/images/ROM35R.jpg"</PhotoImage>]]></Photo>

<Photo sequence="7">

<PhotoPriority>7</PhotoPriority><![CDATA[<PhotoImage>urlimages="http://ws.amandatour.ambergris.it/images/ROM35MT.jpg"</PhotoImage>]]></Photo>

<Photo sequence="8">

<PhotoPriority>10</PhotoPriority><![CDATA[<PhotoImage>urlimages="http://ws.amandatour.ambergris.it/images/ROM35M.jpg"</PhotoImage>]]></Photo>

</HotelPhotoGallery>

</Hotel>

</Response>

</HotelDetailReturn>

</ns1:HotelDetailResponse>

</soapenv:Body>

</soapenv:Envelope>